



# NOVO

Building Products



**MOULDINGS | SHEET GOODS | BOARDS | EXTERIOR MILLWORK**  
**ALLENTOWN DISTRIBUTION CENTER**

# our STORY

## DEEP ROOTS. HIGH STANDARDS. BRIGHT FUTURE.

Founded in 1946, Novo Building Products (previously known as Empire Moulding & Millwork) has grown into one of the largest millwork distribution and manufacturing

companies in the United States. With a geographic footprint that touches the majority of the eastern half of the United States, Novo Building Products is positioned for continued expansion.

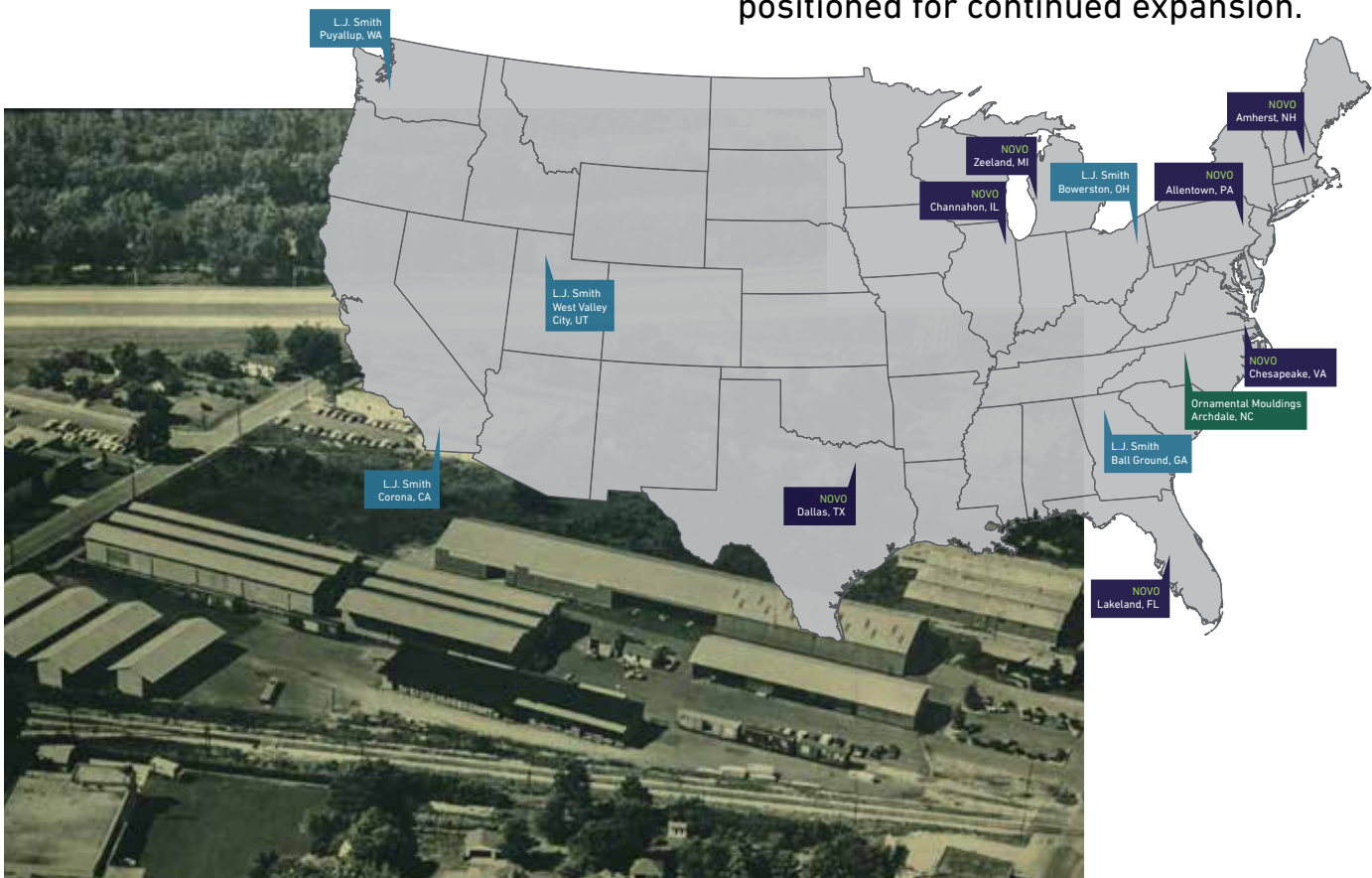

our

# FAMILY

**NOVO BUILDING PRODUCTS IS PROUD TO BE PART OF THE ADENTRA FAMILY.**



Novo Building Products is an industry leading manufacturer and distributor of mouldings, stair parts, doors, and specialty building products. We serve building material dealers (lumberyards), door shops, retail home centers, and millwork manufacturing partners throughout the United States and parts of Canada and Mexico.

Learn more at [NOVOBP.COM](http://NOVOBP.COM).

ADENTRA is one of North America's largest distributors of architectural-grade building and millwork products to the residential and commercial construction industries. Adentra currently operates a network of 86 distribution and fabrication facilities in North America consisting of five industry leading distribution brands: Hardwoods Specialty Products, Mid-Am Supply, Frank Paxton Lumber Company, Rugby Architectural Building Products, and Novo Building Products.

Learn more at [ADENTRAgroup.com](http://ADENTRAgroup.com).





# NOVO

Building Products







# TABLE OF CONTENTS

- OMI CUSTOM MANUFACTURING ..... 7
- INSPIRATION ..... 8 – 21
- BUILD UPS ..... 22-23
- DECORATIVE ACCESSORIES ..... 24-27
- FLEXIBLE MOULDING ..... 28
- SHEET GOODS ..... 29-31
- BOARDS ..... 32
- JAMBS ..... 33
- CASING ..... 34 -36
- DECORATIVE ARCHITRAVES ..... 37
- ROSETTES | PLINTH BLOCKS ..... 38
- CORBELS | BASE BLOCKS ..... 39
- BASE CAPS ..... 40
- BASE ..... 40 – 43
- CROWN ..... 44 – 47
- CROWN BLOCKS | WALL RAILS ..... 48
- STOOLS | WINDOW & DOOR MISC. .... 49
- STOPS | MULLIONS ..... 50
- PANEL MOULD | PLY CAPS
- CHAIR RAILS ..... 51
- MISCELLANEOUS ..... 52
- WALL PANELS ..... 53
- COLUMNS ..... 54
- L.J. SMITH STAIR SYSTEMS ..... 55-57
- INDEX ..... 58
- QUALITY PRODUCTS ..... 59

Achieve a similar look using: **1X6 EC** Wainscoting (V-Groove side)  
**445** Casing | **623** Base | **126** Shoe



## NOVO Building Products is proud to offer a brand new efficient self-service online portal.



Full access to stocked product pricing



Easily place orders on any desktop or mobile device



Receive order status update



Follow the steps below to sign up today!

1. Locate your Customer Code from the "Ship To" line on your order acknowledgment.

2. Navigate to NOVOBP.com. Go to SIGN IN. Select "Create An Account".

3. Fill in all fields marked with "Required" and select "Create Account".

4. Allow 1 business day for account verification, and then explore the new online portal!



# Custom Manufacturing on DEMAND by ORNAMENTAL DECORATIVE MILLWORK



**Quality custom and short run moulding orders with quick turn around!**

Custom Manufacturing  
on DEMAND

## Specs

- 6-16 ft. lengths (random / clear) - Prime available up to 12 ft.
- Profile max = 11-3/4" width
- Minimum run = 3,000 ft. (less than charge can be applied)
- Unique capabilities: rope, dentil, emboss, carving

## Material

- Poplar
- Solid Pine
- Red Oak
- White Oak
- Alder
- Cypress
- Soft Maple
- Hard Maple
- Ambrosia "Rustic" Maple
- Others available upon request and subject to availability

## Timing

- 2-3 days for cost quote and estimated lead time
- Moulding sample or CAD drawing required
- Please contact your Sales Representative



**Made in the USA**

**ORNAMENTAL**

— DECORATIVE MILLWORK —

A NOVO Building Products Company

Visit [NOVOBP.COM](http://NOVOBP.COM)  
to order NOVO  
Building Products  
online





Style is individual, personal, and unique.  
Make your room a reflection of you...

# DISTIN





# GUISH

## YOUR STYLE



RANCH  
CLASSIC  
COLONIAL  
MIDWESTERN  
EARLY AMERICAN  
INVITING & TIMELESS

# Traditional





Achieve a similar look using: Chair Rail | **041** Crown | **5010** Architrave | **445** Casing plus **281** Back Band | **738** Base

## Traditional

Traditional Mouldings enhance any home style from Midwestern, Early American to Coastal. They blend perfectly with the classic style furnishing and timeless building materials of today. NOVO has a vast selection of traditional style mouldings to match and enhance your own unique style.

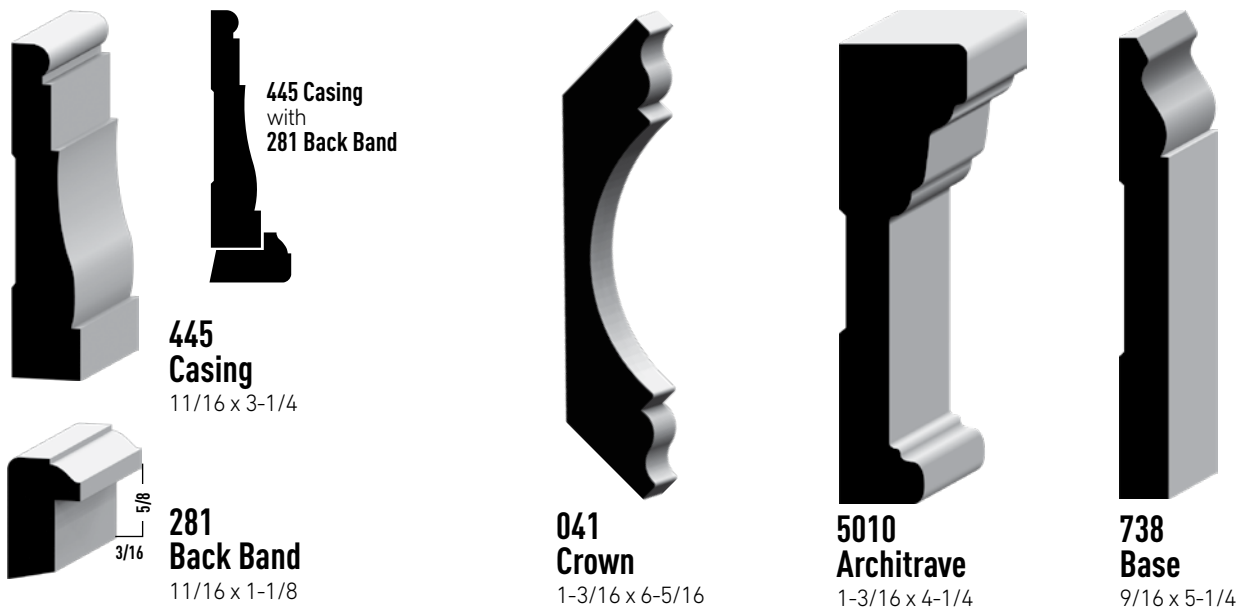

Profiles shown are not to scale.

**WARNING:** Drilling, sawing, sanding or machining wood products can expose you to wood dust, a substance known to the State of California to cause cancer. Avoid inhaling wood dust or use a dust mask or other safeguards for personal protection. For more information go to [www.P65Warnings.ca.gov/wood](http://www.P65Warnings.ca.gov/wood)

# Contemporary

**ARTISTIC  
AVANT-GARDE**

**ECLECTIC YET  
SOPHISTICATED SIMPLICITY**

**FULL OF LIFE, CULTURE,  
COLOR, AND TEXTURE**

**COMBINING UNIQUE, FOUND,  
REPURPOSED OBJECTS, BOTH  
NATURAL & MANUFACTURED  
MATERIALS**





The mouldings listed may not be as shown in the image but are represented to achieve a similar style or look:

STCA Casing | Architrave made by: **1x6 S4S** & **280 Back Band (x2)**  
**STBA Base** | **L 254 Shoe**

## Contemporary

At its core, the word "contemporary" means "of the moment." Sleek & thoughtful, contemporary design spaces often feature a mixture of both straight and elegantly curved lines, which can be seen as a slight nod to this style's art deco roots. Today, the look is defined by curved lines, and embraces minimalistic elements highlighting grays, beiges and shades of white. Although the contemporary trend changes with time, the basic cutting edge simplicity and idealism remains as unique as your vision.

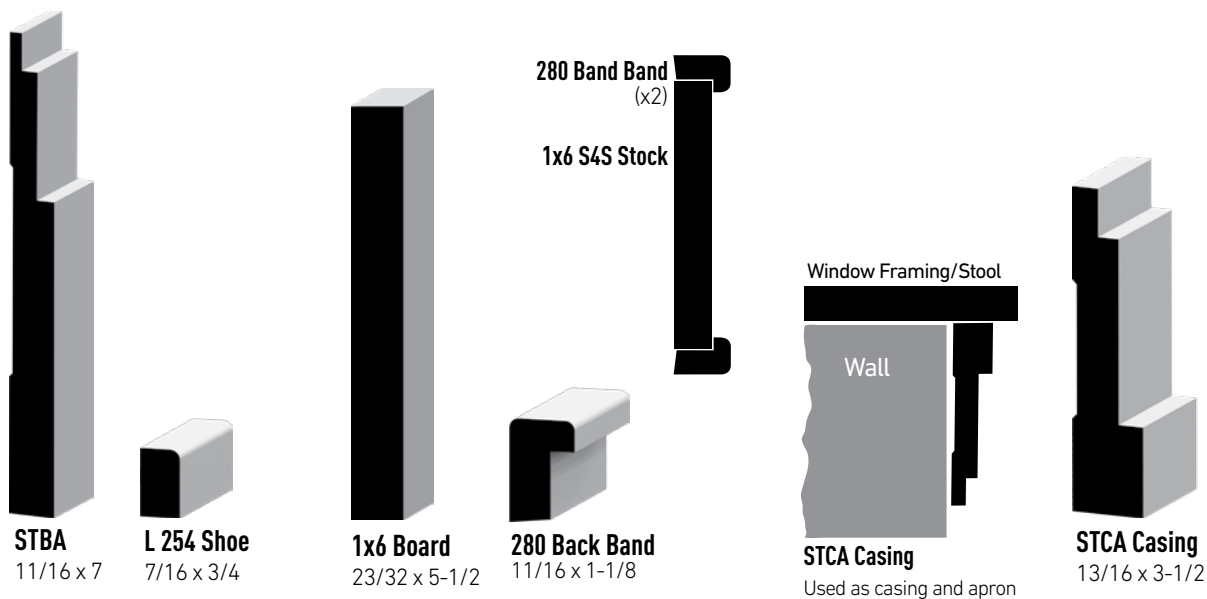

Profiles shown are not to scale.

**WARNING:** Drilling, sawing, sanding or machining wood products can expose you to wood dust, a substance known to the State of California to cause cancer. Avoid inhaling wood dust or use a dust mask or other safeguards for personal protection. For more information go to [www.P65Warnings.ca.gov/wood](http://www.P65Warnings.ca.gov/wood)





# Victorian

GLAMOROUS  
ORNATE  
ART DECO  
BAROQUE  
SOUTHERN PLANTATION  
COLONIAL ESTATE







The mouldings listed may not be as shown in the image but are represented to achieve a similar style or look:

Crown Buildup: **L 340** Crown & **738** Base | **8412** Cap | **S RB3** Casing |  
Base Buildup: **738** Base & **S RB3** Casing

## Victorian

Victorian Mouldings hearken to the richness of old world artisan builders, craftsman and clothiers that regarded every part of their work a piece of art. It is a style that can transform the bland into a bold statement of line and form. Ornate mouldings can be combined to restore a great Painted Lady or add a subtle flair and richness to add glamour to any room in your home.

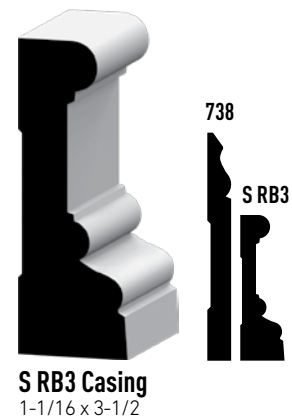
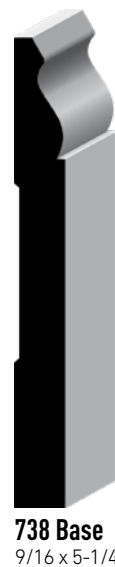
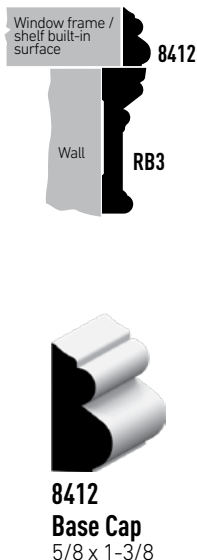
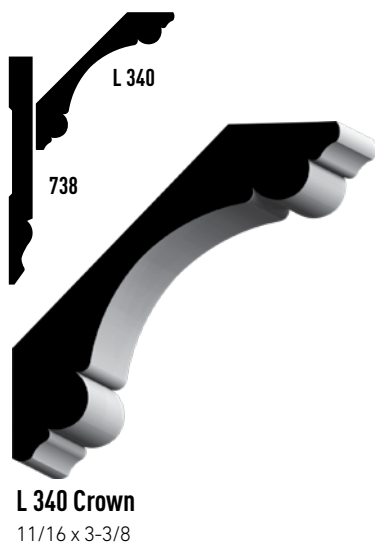

Profiles shown are not to scale.

**WARNING:** Drilling, sawing, sanding or machining wood products can expose you to wood dust, a substance known to the State of California to cause cancer. Avoid inhaling wood dust or use a dust mask or other safeguards for personal protection. For more information go to [www.P65Warnings.ca.gov/wood](http://www.P65Warnings.ca.gov/wood)





# Farmhouse

FARM & COTTAGE, RUSTIC & FINISHED, HANDCRAFTED & MILLED  
NATURAL & PAINTED WOODS, STURDY BEAMS & HEADERS  
LIVABLE LUXURY — FRONTIER SIMPLICITY...  
WORK... RESTORE





The mouldings listed may not be as shown in the image but are represented to achieve a similar style or look:

**B G312 Casing w/B G200 Back Band Casing** | **1x6 Board** - Window Stool  
**B G512 Base** | **B G100 Shoe** | **L SL16 Shiplap**  
**BEAMRUSTIC-8WM5x3 Faux Beam**

## Farmhouse

Classic, elegant and comfortable, the modern farmhouse decorating is rooted in rustic country charm peppered with warm minimalism. Striking just the right balance of pastoral and refined, modern farmhouse decor emphasizes comfort and casual living with contemporary sensibilities reflective of today's times. NOVO stocks a wide variety of hardwood and primed mouldings, boards, and wall panels from wainscoting, bead-board to shiplap. Combined with faux beams from Ornamental Mouldings to create warm and inviting spaces from cozy to dramatic and inviting for a family gathering.

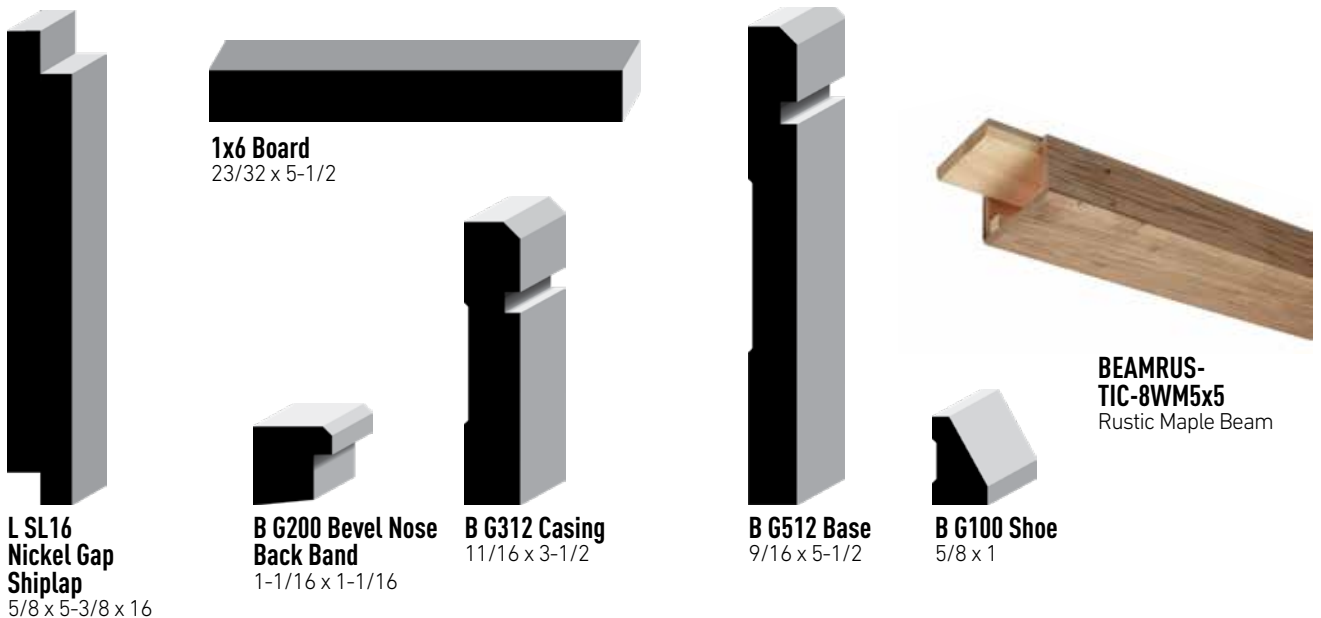

**L SL16 Nickel Gap Shiplap**  
 5/8 x 5-3/8 x 16

**1x6 Board**  
 23/32 x 5-1/2

**B G200 Bevel Nose Back Band**  
 1-1/16 x 1-1/16

**B G312 Casing**  
 11/16 x 3-1/2

**B G512 Base**  
 9/16 x 5-1/2

**B G100 Shoe**  
 5/8 x 1

**BEAMRUSTIC-8WM5x5**  
 Rustic Maple Beam

Profiles shown are not to scale.

**⚠ WARNING:** Drilling, sawing, sanding or machining wood products can expose you to wood dust, a substance known to the State of California to cause cancer. Avoid inhaling wood dust or use a dust mask or other safeguards for personal protection. For more information go to [www.P65Warnings.ca.gov/wood](http://www.P65Warnings.ca.gov/wood)

# Craftsman





**LINE & STRUCTURE  
HANDCRAFTED  
ARCHITECTURAL  
ARTISAN-CRAFTSMAN  
MODERN-FARMHOUSE  
WESTERN RANCH**



*The mouldings listed may not be as shown in the image but are represented to achieve a similar style or look:*

**5010 Architrave | 412 Casing | L 432 Casing w/280 Back Band  
L 414 E1E Base w/280 Back Band | L 254 Shoe  
BEAMRUSTIC-8WM5x5 Faux Beam**

## Craftsman

Craftsman homes are full of endless detail and character, known for their natural materials, cozy interiors, and wide porches. Patterns and lines show the Arts & Crafts Architectural style through the use of natural woods combined with simple paint schemes. Wainscoting or beadboard detailing, and decorated ceilings with beams will help to give your home that warm feeling.



**5010 Architrave**  
1-3/16 x 4-1/4



**412 E2E Casing**  
19/32 x 3-1/2



**L 432 E1E Casing**  
9/16 x 3-1/2



**8416  
Base Cap**  
5/8 x 1-5/8



**280 Back Band**  
11/16 x 1-1/8



**L 414 E1E Base**  
9/16 x 4-1/4



**BEAMRUSTIC-  
TIC-8WM5x5**  
Rustic Maple Beam

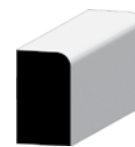

**L 254 Craftsman Shoe**  
7/16 x 3/4

Profiles shown are not to scale.

**WARNING:** Drilling, sawing, sanding or machining wood products can expose you to wood dust, a substance known to the State of California to cause cancer. Avoid inhaling wood dust or use a dust mask or other safeguards for personal protection. For more information go to [www.P65Warnings.ca.gov/wood](http://www.P65Warnings.ca.gov/wood)



# Craftsman | Sleek, Modern, Simple

## Crown



**E519**  
9/16 x 4-1/4  
MDF 16'



**CR291**  
3/4 x 5-1/4  
MDF 16'



**505**  
1 x 7  
MDF 16'

## Base Cap | Base



**B GC1**  
**Slant Cap**  
3/4 x 1-1/16  
PRIMED 16'



**B GC2**  
**Chamfer Cap**  
3/4 x 1-1/16  
PRIMED 16'



**L 433E E1E**  
1/2 x 3-1/4  
MDF 16'



**L 414 E1E**  
9/16 x 4-1/4  
PRIMED 16'



**B G412**  
11/16 x 4-1/2  
PRIMED 16'



**W B514**  
9/16 x 5-1/4  
PRIMED 16'



**L 514 E1E**  
9/16 x 5-1/4  
PRIMED 16'



**512E E1E**  
1/2 x 5-1/2  
MDF 16'



**B G512**  
9/16 x 5-1/2  
PRIMED 16'  
MDF 16'



**L 714E E1E**  
9/16 x 7-1/4  
PRIMED 16'



**B G712**  
9/16 x 7-1/2  
PRIMED 16'  
MDF 16'

**L 512 E1E**  
9/16 x 5-1/2  
PRIMED 16'

**714E E1E**  
1/2 x 7-1/4  
MDF 16'

## Shoe

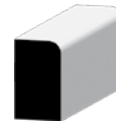

**L 254 Shoe**  
7/16 x 3/4  
PRIMED  
8' | 12' | 16'



**B G100 Shoe**  
5/8 x 1  
PRIMED  
16'



# Craftsman | Sleek, Modern, Simple

## Back Band

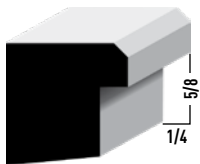

**B G200 Bevel Nose Back Band**  
1-1/16 x 1-1/16  
PRIMED 16'

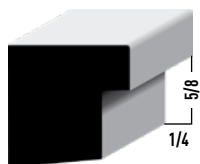

**B G250 Eased Nose Back Band**  
1-1/16 x 1-1/16  
PRIMED 16'



STCA Casing | STCB Base | L 254 Shoe

## Casing



**L 473 E2E**  
19/32 x 2-1/4  
MDF 7'6" | 15'



**472 E2E**  
9/16 x 2-1/2  
PRIMED 16'  
19/32 x 2-1/2  
MDF 16'



**452 E2E**  
11/16 x 2-1/2  
PRIMED 7'2



**L 452 E1E**  
11/16 x 2-1/2  
PRIMED 7'2" | 16'  
9/16 x 2-1/2  
MDF 16'



**B G212**  
11/16 x 2-1/2  
PRIMED 16'  
MDF 16'



**B G312**  
11/16 x 3-1/2  
PRIMED 16'  
MDF 16'



**L 412 E1E**  
11/16 x 3-1/2  
PRIMED 16'



**412 E2E**  
19/32 x 3-1/2  
MDF 16'



**432 E2E**  
9/16 x 3-1/2  
PRIMED 16'



**L 432 E1E**  
9/16 x 3-1/2  
PRIMED 16'



**W C312**  
11/16 x 3-1/2  
PRIMED 16'



**STCA**  
13/16 x 3-1/2  
PRIMED 16'



**SCCA**  
13/16 x 3-1/2  
PRIMED 16'

**E 412 E2E**  
11/16 x 3-1/2  
PRIMED 16'

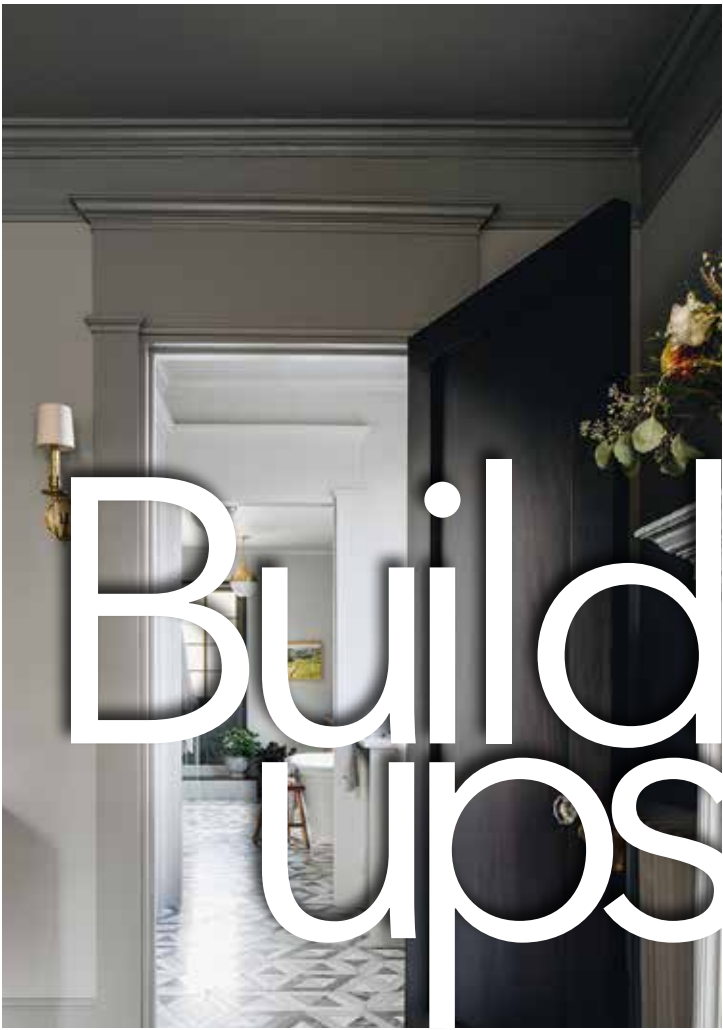

## Combine moulding patterns to create a unique home style.

- Combine crowns, bases, casing, panel moulds, shoe or quarter rounds and more, to create detail, line and pattern.
- Use boards or square stock to build up depth.
- Combine square and eased edges to create richer detail.
- Use moulding with the same style families for a harmonious feel.
- Create completely unique build-ups to fit your own style.



Build-Ups can dramatically change any space adding rich detail for low-cost.

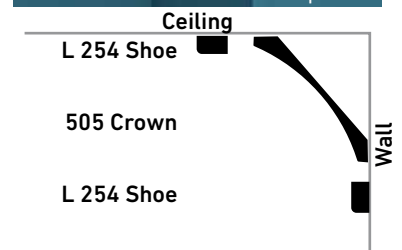
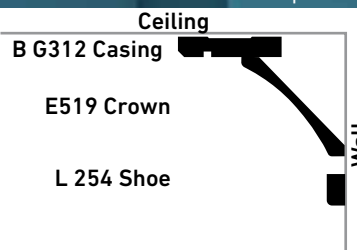



**Build-Up combinations are as limitless as your imagination.  
Create a look that is uniquely you.**

## Build-Ups | Fireplace Surround

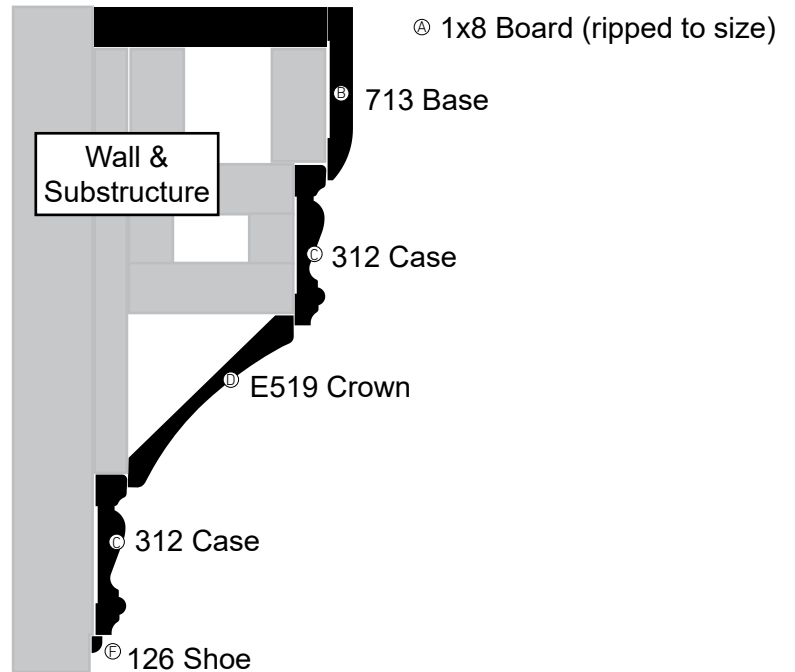

## Build-Ups | Casing



- A L 887 Mullion
- B 444 Casing
- C 93 Cove

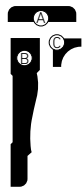

- A L 49 Crown
- B 1X4 S4S
- C 93 Cove

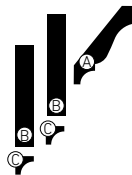

L 340 Crown A

738 Base B

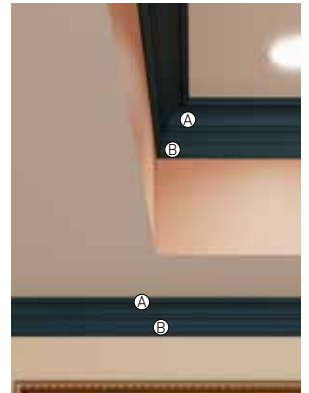

## Build-Ups | Crown

## Build-Ups | Base



- A 7163 Base
- B 738 Base
- C 947 Stop

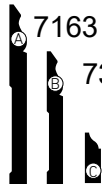

- A 126 Shoe
- B 1X6 S4S
- C 663 Base
- D 106 Quarter Round

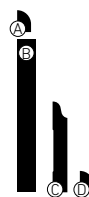

## Build-Ups | Chair



- A W 956 Chair Rail Backer
- B 300 Chair Rail

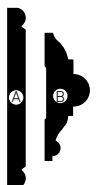

# Decorative Accessories

## ORNAMENTAL

DECORATIVE MILLWORK

A NOVO Building Products Company

Expressing a style comes easier and has greater impact when your choices—from ceiling to floor—are all unified. For nearly 100 years, Ornamental Mouldings has been providing distinctive, high-quality millwork to make entire living spaces more beautiful. Our decorative accessory styles inspired by tradition and shaped by the latest trends complement one another for unmatched selection, all in one place.

### Mantels and Floating Shelves

Whenever people enter a room, their eyes instantly take stock of the space. Reward their gaze with our Mantels and Floating Shelves, which marry function with details that convey a discerning sensibility.



Pattern	Product	H	D	L	Species
3 Ft. Mantel	<b>3WM ORRMP</b>	5	7	36	Rustic maple
4 Ft. Mantel	<b>4WM ORRMP</b>	5	7	48	
5 Ft. Mantel	<b>5WM ORRMP</b>	5	7	60	
6 Ft. Mantel	<b>6WM ORRMP</b>	5	7	72	



3 Ft. Mantel with insert	<b>B 3WM 01 ORRMP</b>	5	7	36	Rustic maple with aspen insert
4 Ft. Mantel with insert	<b>B 4WM 01 ORRMP</b>	5	7	48	
5 Ft. Mantel with insert	<b>B 5WM 01 ORRMP</b>	5	7	60	
6 Ft. Mantel with insert	<b>B 6WM 01 ORRMP</b>	5	7	72	



4 Ft. Mantel	<b>CLAS 4 ORWHW</b>	3 3/4	7 3/4	48	WHW
5 Ft. Mantel	<b>CLAS 5 ORWHW</b>	3 3/4	7 3/4	60	WHW
6 Ft. Mantel	<b>CLAS 6 ORWHW</b>	3 3/4	7 3/4	72	WHW



5 Ft. Mantel	<b>CLAS 5 OROAK</b>	3 3/4	7 3/4	60	Oak
6 Ft. Mantel	<b>CLAS 6 OROAK</b>	3 3/4	7 3/4	72	Oak





Farmhouse | **OML14B, OML24C** | Mantel and Beams

## Wood Beams



Practical elements like ceiling beams and wooden stairs are prime places for expressing your style. Our Wood Beams and Decorative Stair Parts give you the tools to achieve drama or convey delicate detailing.

Pattern	Product	H	W	L	Species
Prefinished gray beam	<b>3 BEAM 8 ORPGY</b>	3	5	96	Gray WHW
Prefinished gray beam	<b>5 BEAM 8 ORPGY</b>	5	5	96	Gray WHW
Rustic maple beam	<b>3 BEAM 8 ORRMP</b>	3	5	96	Rustic maple
Rustic maple beam	<b>5 BEAM 8 ORRMP</b>	5	5	96	Rustic maple
3 inch metal beam-band/bracket	<b>3 BRKT 5 METAL</b>	3 <sup>9</sup> / <sub>64</sub>	1 1/2	6 <sup>7</sup> / <sub>16</sub>	Metal
5 inch metal beam-band/bracket	<b>5 BRKT 5 METAL</b>	5 <sup>17</sup> / <sub>64</sub>	1 1/2	6 <sup>5</sup> / <sub>16</sub>	Metal



## Decorative Boards

Create an impact that is more than meets the eye. Use our Decorative Boards to express your creativity with combinations that even at first glance speak volumes about your personal style.



Pattern	Product	W	T	L	Species
Decorative boards	<b>A 1X2 8 MAPLE</b>	1 1/2	7/16	96	Ambrosia Maple
	<b>12X2 8 ORWOK</b>	1 1/2	7/16	96	White Oak
Decorative boards eased edge two sides	<b>12X2 8 ORPGY</b>	1 1/2	7/16	96	Gray Stain
	<b>12X2 8 ORPBK</b>	1 1/2	7/16	96	Black Stain
Decorative boards	<b>A 1X4 8 MAPLE</b>	3 1/2	7/16	96	Ambrosia Maple
	<b>12X4 8 ORWOK</b>	3 1/2	7/16	96	White Oak
Decorative boards eased edge two sides	<b>12X4 8 ORPGY</b>	3 1/2	7/16	96	Gray Stain
	<b>12X4 8 ORPBK</b>	3 1/2	7/16	96	Black Stain
Decorative boards	<b>A 1X6 8 MAPLE</b>	5 1/2	7/16	96	Ambrosia Maple
Decorative boards eased edge two sides	<b>12X6 8 ORPGY</b>	5 1/2	7/16	96	Gray Stain
	<b>12X6 8 ORPBK</b>	5 1/2	7/16	96	Black Stain





Modern Farmhouse | PD001MD742PRIM

## Decorative Stair Parts

Pattern	Product	H	W	T	Species
Primed reversible decorative stair riser	<b>PD001MD742PRIM</b>	7 1/2	42	11/32	MDF
	<b>PD001MD748PRIM</b>	7 1/2	48	11/32	MDF



Primed reversible decorative oak stair riser	<b>PD002OAK742PRIM1</b>	7 1/2	42	11/32	Oak/Prime
	<b>PD002OAK748PRIM1</b>	7 1/2	48	11/32	Oak/Prime

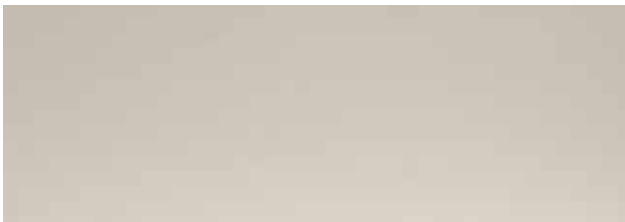

**Prominent.  
Beautiful.  
Flexible.**

## THE CARTER MILLWORK ADVANTAGE

Carter Millwork products are made of polyurethane material - a strong, long-lasting and cost-effective alternative to wood and polyester. Each piece of our moulding is individually inspected to ensure compliance to our exacting quality standards.

There are many reasons to choose Carter Millwork products:

- An extensive selection of in-stock items available for immediate shipment
- Thousands of unique profiles available
- Unlimited custom capabilities from historic replicas to contemporary designs
- Polyurethane non-shrink product for compatibility to any moulding profile
- Impervious to moisture - interior or exterior use
- Paintable or stainable - cuts like wood
- Fastest custom order turnaround in the industry
- Stock products shipped within 21 days on custom orders
- Competitive prices
- No minimum order size
- Warranty that moulding is free from defects in materials and workmanship for as long as the original purchaser owns the structure

### HALF ROUND

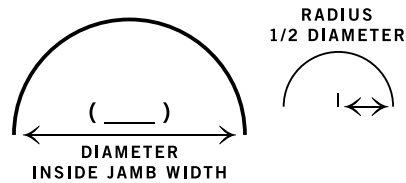

### ARCS

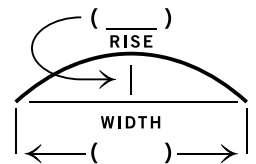

### ELLIPSES

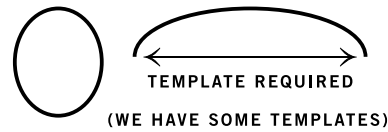

### RADIUS CROWN

CONVEX-OSR  
FOR CROWN & CEILING BACKER

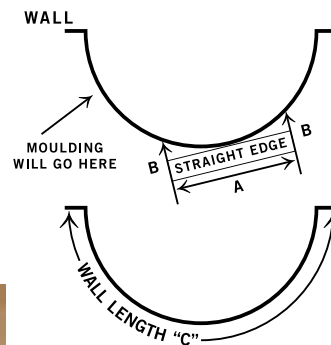

WE NEED "A" LENGTH  
"B" DISTANCE & "C" LENGTH

CONCAVE-ISR  
FOR CROWN & CEILING BACKER

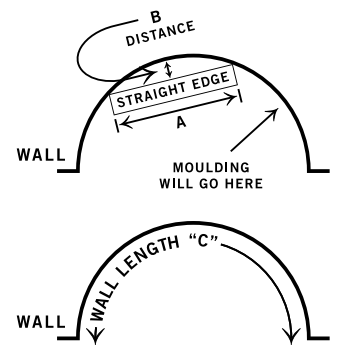

WE NEED "A" LENGTH  
"B" DISTANCE & "C" LENGTH







# NOVO

Building Products

HARDWOOD  
PLYWOOD

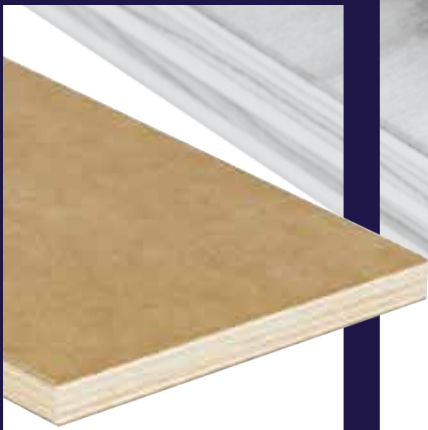

THERMALLY  
FUSED  
LAMINATE



MEDIUM  
DENSITY  
FIBERBOARD



# NOVO SHEET GOODS PROGRAM

PREMIUM SHEETS FOR HUNDREDS  
OF INTERIOR APPLICATIONS

WIDE SELECTION OF SKU OFFERINGS

DELIVERED ON YOUR NEXT TRUCK ALONG  
WITH YOUR MOULDING AND MILLWORK

NOVOBP.COM | 800.253.9000



## Sheet Goods

### Premium Hardwood - Plywood

NOVO SKU	SPECIE	THICKNESS (IMPERIAL)	THICKNESS (METRIC)	GRADE	SIZE
<b>BIRCH</b>					
144 8 BCPLY	Domestic Natural WPF	1/4"	N/A	A4	48" x 96"
124 8 BCPLY	Domestic Natural WPF	1/2"	N/A	A1	48" x 96"
344 8 BCPLY	Domestic Natural WPF	3/4"	N/A	A1	48" x 96"
M 524 8 BCPLY	Cabinet Grade White	1/4"	5.2mm	C4	48" x 96"
M 124 8 BCPLY	Cabinet Grade White	1/2"	12mm	C2	48" x 96"
M 184 8 BCPLY	Cabinet Grade White	3/4"	18mm	C2	48" x 96"
<b>OAK</b>					
144 8 OKPLY	Domestic WPF	1/4"	N/A	A4	48" x 96"
124 8 OKPLY	Domestic WPF	1/2"	N/A	A1	48" x 96"
344 8 OKPLY	Domestic WPF	3/4"	N/A	A1	48" x 96"
<b>MAPLE</b>					
T 124 8 MPPLY	White UV 2 sides	1/2" UV2S	N/A	Premium	48" x 96"
T 344 8 MPPLY	White UV 2 sides	3/4" UV2S	N/A	Premium	48" x 96"
344 8 MPPLY	White	3/4"	N/A	Premium	48" x 96"
<b>MERANTI (LAUAN)</b>					
M 274 8 MRPLY	MERANTI	1/8"	2.7mm	OVL/BTR	48" x 96"
M 524 8 MRPLY	MERANTI	1/4"	5.2mm	OVL/BTR	48" x 96"
<b>PINE</b>					
144 8 PNPLY	PINE	1/4"	6.5mm	AC	48" x 96"
384 8 PNPLY	PINE	3/8"	9mm	AC	48" x 96"
124 8 PNPLY	PINE	1/2"	12mm	AC	48" x 96"
584 8 PNPLY	PINE	5/8"	15mm	AC	48" x 96"
344 8 PNPLY	PINE	3/4"	18mm	AC	48" x 96"
784 8 PNPLY	PINE	1"	25mm	AC	48" x 96"

🌿 ALL NOVO HARDWOOD PLYWOOD SHEETS MEET OR EXCEED HPVA SPECIFICATIONS



## Sheet Goods Sheets & Shelving

NOVO SKU	SPECIE	THICKNESS (IMPERIAL)	THICKNESS (METRIC)	GRADE	SIZE
<b>TFL (THERMALLY FUSED LAMINATE)</b>					
<b>344 8 TFPLY</b>	GOOD 2 SIDE	3/4"	N/A	N/A	49" x 97"
<b>3412 8 TFPLY</b>	EDGE BANDED 1 SIDE	3/4"	N/A	N/A	12" (11-1/4) x 96"
<b>3416 8 TFPLY</b>	EDGE BANDED 1 SIDE	3/4"	N/A	N/A	16" (15-1/4) x 96"
<b>3424 8 TFPLY</b>	EDGE BANDED 1 SIDE	3/4"	N/A	N/A	24" (23-1/4) x 96"



## Sheet Goods Medium Density Fiberboard

NOVO SKU	SPECIE	THICKNESS (IMPERIAL)	THICKNESS (METRIC)	GRADE	SIZE
<b>FIBERBOARD</b>					
<b>M 554 8 MDPLY</b>	Ultra-Lite MDF	1/4"	5.5mm	N/A	48" x 96"
<b>M 94 8 MDPLY</b>	Ultra-Lite MDF	3/8"	9mm	N/A	48" x 96"
<b>M 124 8 MDPLY</b>	Ultra-Lite MDF	1/2"	12mm	N/A	48" x 96"
<b>M 154 8 MDPLY</b>	Ultra-Lite MDF	5/8"	15mm	N/A	48" x 96"
<b>M 184 8 MDPLY</b>	Ultra-Lite MDF	3/4"	18mm	N/A	48" x 96"
<b>M 254 8 MDPLY</b>	Ultra-Lite MDF	1"	25mm	N/A	48" x 96"

ALL NOVO TFL AND MDF SHEETS ARE TSCA IV COMPLIANT and CARB APPROVED



# Boards



**Approx. 250 BD. Feet  
Random Length Unit  
Mini-Packs Available  
Oak | Poplar**

<b>1 X 2</b>	23/32 x 1-1/2	<b>PRIMED</b>	8'   12'   16''
<b>1 X 3</b>	23/32 x 2-1/2	<b>PRIMED</b>	16'
<b>1/2 X 4</b>	1/2 x 3-1/2	<b>PRIMED</b>	16'
<b>1/2 X 6</b>	1/2 x 5-1/2	<b>PRIMED</b>	16'
<b>1 X 4</b>	3/4 x 3-1/2	<b>PINE</b>	8'   10'   12'   14'   16'
	23/32 x 3-1/2	<b>PRIMED</b>	8'   16'
	11/16 x 3-1/2	<b>MDF</b>	8'   16'   17'
	3/4 x 3-1/2	<b>OAK</b>	8'   10'   12'   16'
	3/4 x 3-1/2	<b>POPLAR</b>	8'   10'   12'   16'
<b>1 X 5</b>	23/32 x 4-1/2	<b>PRIMED</b>	8'   16'
<b>1 X 6</b>	3/4 x 5-1/2	<b>PINE</b>	8'   10'   12'   14'   16'
	23/32 x 5-1/2	<b>PRIMED</b>	8'   16'
	11/16 x 5-1/2	<b>MDF</b>	8'   16'
	3/4 x 5-1/2	<b>OAK</b>	8'   10'   12'   14'   16'
	3/4 x 5-1/2	<b>POPLAR</b>	8'   10'   12'   16'
<b>1 X 8</b>	3/4 x 7-1/4	<b>PINE</b>	8'   10'   12'   14'   16'
	23/32 x 7-1/4	<b>PRIMED</b>	8'   16'
	11/16 x 7-1/4	<b>MDF</b>	8'   16'
	3/4 x 7-1/4	<b>OAK</b>	8'   10'   12'   16'
	3/4 x 7-1/4	<b>POPLAR</b>	8'   10'   12'   16'
<b>1 X 10</b>	3/4 x 9-1/4	<b>PINE</b>	8'   10'   12'   14'   16'
	23/32 x 9-1/4	<b>PRIMED</b>	8'   16'
	11/16 x 9-1/4	<b>MDF</b>	16'
	3/4 x 9-1/4	<b>OAK</b>	8'   10'   12'   14'   16'
	3/4 x 9-1/4	<b>POPLAR</b>	8'   10'   12'   16'
<b>1 X 12</b>	3/4 x 11-1/4	<b>PINE</b>	8'   10'   12'   14'   16'
	23/32 x 11-1/4	<b>PRIMED</b>	8'   16'
	11/16 x 11-1/4	<b>MDF</b>	16'
	3/4 x 11-1/4	<b>OAK</b>	8'   10'   12'   14'
	3/4 x 11-1/4	<b>POPLAR</b>	8'   10'   12'   16'
<b>5/4 X 4</b>	1-1/16 x 3-1/2	<b>PRIMED</b>	16'
<b>5/4 X 6</b>	1-1/16 x 5-1/2	<b>PRIMED</b>	16'
<b>5/4 X 8</b>	1-1/16 x 7-1/4	<b>PRIMED</b>	16'
<b>5/4 X 10</b>	1-1/16 x 9-1/4	<b>PRIMED</b>	16'
<b>5/4 X 12</b>	1-1/16 x 11-1/4	<b>PRIMED</b>	16'



**PINE**



**OAK**



**POPLAR**

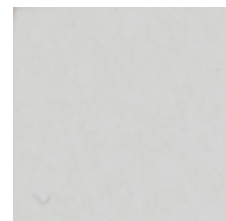

**PRIMED**



Don't forget your casing: STCA Casing | STBA Base | L 254 Shoe

## Door Jambs

	JAMB SIZE	DIMENSION	BELOW DADO	PRIMED	PINE VENEER
6'8" FLAT JAMBS	478 6'8"	11/16 X 4-7/8 JAMB PAIR	81"	X	
	4916 6'8"	11/16 X 4-9/16 JAMB PAIR	81"	X	X
	X 4916 6'8"	11/16 X 4-9/16 JAMB SIDE	81"		X
	678 6'8"	11/16 X 6-7/8 FLAT JAMB PAIR	81"	X	
	6916 6'8"	11/16 X 6-9/16 JAMB PAIR	81"	X	X
6'9" FLAT JAMBS	L 458 6'9"	11/16 X 4-5/8 JAMB PAIR W/ LUG	81-1/2"	X	
	478 6'9"	11/16 X 4-7/8 FLAT JAMB PAIR	81-1/2"	X	
	4916 6'9"	11/16 X 4-9/16 JAMB PAIR	81-1/2"	X	
	6916 6'9"	11/16 X 6-9/16 JAMB PAIR	81-1/2"	X	
7'0" FLAT JAMBS	478 7'0"	11/16 X 4-7/8 FLAT JAMB PAIR	85"	X	
	4916 7'0"	11/16 X 4-9/16 JAMB PAIR	85"	X	
8'0" FLAT JAMBS	378 8'0"	11/16 X 3-7/8 JAMB PAIR	97"	X	
	478 8'0"	11/16 X 4-7/8 FLAT JAMB PAIR	97"	X	
	4916 8'0"	11/16 X 4-9/16 JAMB PAIR	97"	X	
	678 8'0"	11/16 X 6-7/8 FLAT JAMB PAIR 97BD	97"	X	
	6916 8'0"	11/16 X 6-9/16 JAMB PAIR	97"	X	
SPLIT JAMB	2 4916 6'8"	4-9/16 X 2-3/4 FM X 2-1/2 M SPLIT JAMB PAIR	80-9/16"	X	
	514 6'8"	5-1/4 X 2-3/4 FM X 2-3/4 M SPLIT JAMB PAIR	80-9/16"	X	
LINEAL JAMBS	4916 R7 (17')	11/16 X 4-9/16 JAMB LINEAL	NA	X	
	6916 R7 (17')	11/16 X 6-9/16 JAMB LINEAL	NA	X	

# Casing



**376**  
 19/32 x 2-1/4  
 MDF 7'1" | 14'  
 11/16 x 2-1/4  
 PRIMED 7'1" | 10' | 14'  
 PINE 7' | 10' | 14'



**L 356**  
 1/2 x 2-1/4  
 OAK 7' | 10'



**356**  
 11/16 x 2-1/4  
 PRIMED 7'1" | 14'  
 PINE 7'  
 5/8 x 2-1/4  
 OAK 7'



**366**  
 11/16 x 2-1/4  
 PRIMED 7' | 14'  
 PINE 7'



**327**  
 11/16 x 2-1/4  
 PRIMED 7' | 14'  
 PINE 7' | 16'



**366A**  
 19/32 x 2-1/4  
 MDF 7' | 14'



**B G212**  
 11/16 x 2-1/2  
 MDF 16'  
 PRIMED 16'



**331**  
 11/16 x 2-1/2  
 PINE 7' | RL



**361**  
 19/32 x 2-1/2  
 MDF 15'  
 11/16 x 2-1/2  
 PRIMED 7' | 16'  
 PINE 7' | RL



**L BRB3**  
 3/4 x 2-1/2  
 PRIMED 16'



**L 473 E2E**  
 19/32 x 2-1/4  
 MDF 7'6" | 15'



**472 E2E**  
 9/16 x 2-1/2  
 PRIMED 16'  
 19/32 x 2-1/2  
 MDF 16'



**452 E2E**  
 11/16 x 2-1/2  
 PRIMED 7'2"

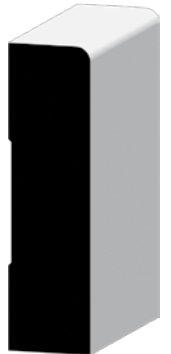

**L 452 E1E**  
 11/16 x 2-1/2  
 PRIMED 7'2" | 16'  
 9/16 x 2-1/2  
 MDF 16'



# Casing



**312**  
19/32 x 3  
MDF 8'



**682**  
1 x 3-1/4  
MDF 16'



**445A**  
11/16 x 3-1/4  
MDF 16'



**445**  
19/32 x 3-1/4  
MDF 16'  
11/16 x 3-1/4  
PRIMED 7'3" | 16'  
PINE 8' | 16'



**W 331**  
11/16 x 3-1/2  
PINE RL



**W C312**  
11/16 x 3-1/2  
PRIMED 16'

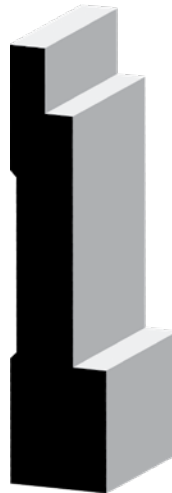

**STCA**  
13/16 x 3-1/2  
PRIMED 16'



**535**  
11/16 x 3-1/2  
MDF 16'



**SCCA**  
13/16 x 3-1/2  
PRIMED 16'



**B G312**  
11/16 x 3-1/2  
MDF 16'  
PRIMED 16'



**L 361**  
11/16 x 3-1/2  
PRIMED 8' | 16'



**444**  
11/16 x 3-1/2  
PRIMED 7'3" | 16'

# Casing



**L 445 (99)**  
11/16 x 3-1/2  
PRIMED 16'



**DC97**  
1 x 3-1/2  
MDF 16'  
1-1/16 x 3-1/2  
PRIMED 16'



**RB3**  
1 x 3-1/2  
MDF 16'



**S RB3**  
1-1/16 x 3-1/2  
PRIMED 16'



**L 412 E1E**  
11/16 x 3-1/2  
PRIMED 16'



**412 E2E**  
9/16 x 3-1/2  
PRIMED 16'



**E 412 E2E**  
11/16 x 3-1/2  
PRIMED 16'



**412 E2E**  
19/32 x 3-1/2  
MDF 16'

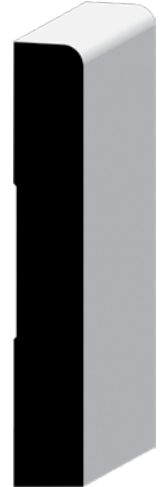

**L 432 E1E**  
9/16 x 3-1/2  
PRIMED 7'4" | 16'



**LK4 CASING**  
1-1/8 x 4  
MDF 16'



**8746 CASING**  
11/16 x 4-1/4  
PRIMED 8'



**5010 Architrave**  
1-3/16 x 4-1/4  
MDF 16'



## Decorative Craftsman Architraves

## ORNAMENTAL

DECORATIVE MILLWORK

A NOVO Building Products Company

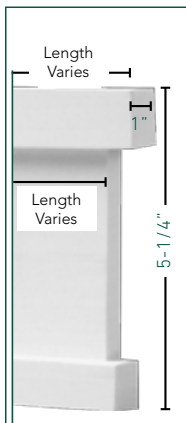

Description	Type / Finish	Actual Length	Used With	NOVO SKU #
24" Craftsman Style Architrave	Primed Poplar	32-5/8"	24" Opening	CSHD 24 ORPMP
28" Craftsman Style Architrave	Primed Poplar	36-5/8"	28" Opening	CSHD 28 ORPMP
30" Craftsman Style Architrave	Primed Poplar	38-5/8"	30" Opening	CSHD 30 ORPMP
32" Craftsman Style Architrave	Primed Poplar	40-5/8"	32" Opening	CSHD 32 ORPMP
36" Craftsman Style Architrave	Primed Poplar	44-5/8"	36" Opening	CSHD 36 ORPMP



Scan to place orders on our NEW NOVO ProDealer Portal [NOVOBP.COM](http://NOVOBP.COM)



# Rosettes | Plinth Blocks



**Bullseye Rosette**  
**B 642C**  
 5/8 x 2-1/2  
 WHITE WOOD

**B 734C**  
 27/32 x 3-1/2  
 WHITE WOOD

**B 740C**  
 27/32 x 4-1/2  
 WHITE WOOD



**Floral Rosette - Beveled**  
**B 871C**  
 1-1/16 x 3-1/2  
 WHITE WOOD

**B 915C**  
 27/32 x 2-1/2  
 WHITE WOOD



**Bullseye Rosette - Beveled**  
**1400C**  
 7/8 x 2-3/4  
 PRIMED

**1402C**  
 7/8 x 3-3/4  
 PRIMED

**334C**  
 7/8 x 3-3/4  
 MDF

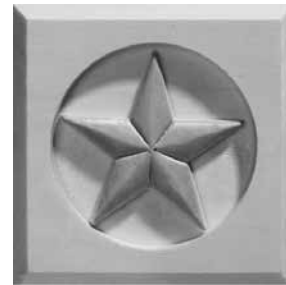

**Star Rosette - Beveled**  
**B 1200C**  
 1-1/16 x 3-1/2  
 WHITE WOOD



**Plinth Block - Beveled**  
**P 1401**  
 7/8 x 2-3/4 x 4-1/2  
 PRIMED

**P 1403**  
 7/8 x 3-3/4 x 6  
 PRIMED

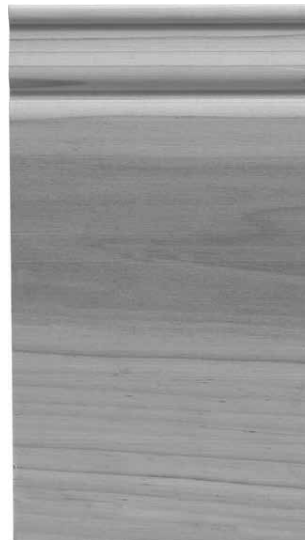

**Plinth Block - Moulded**  
**PB 887**  
 27/32 x 2-1/2 x 5-3/4  
 WHITE WOOD

**PB 742**  
 1-1/16 x 3-1/2 x 6-1/2  
 WHITE WOOD

**PB 334**  
 1 x 3-3/4 x 9  
 MDF

**PB 743**  
 1-1/16 x 4-1/2 x 8  
 WHITE WOOD

# Corbels | Base Blocks



**C A8 ORCRW**  
**Decorative Corbel**  
 5-1/2 x 4-5/8 x 9-13/16  
 MAPLE



**C A8 ORPWH**  
**Decorative Corbel**  
 5-1/2 x 4-5/8 x 9-13/16  
 PAINTED WHITE



**CA60 ORPWH**  
**Decorative Corbel**  
 9 x 3-1/2 x 12  
 PAINTED WHITE



**C A110 ORMAP**  
**Shelf or Counter Bracket**  
 8 x 3 x 12  
 MAPLE



**CA70 ORMAP**  
**Classic Corbel**  
 6-1/2 x 3 x 12  
 MAPLE



**CA70 ORPWH**  
**Classic Corbel**  
 6-1/2 x 3 x 12  
 PAINTED WHITE



**Base Block -  
 Outside Corner**  
**B 892**  
 1-1/8 x 6-3/4  
 WHITE WOOD



**Base Block -  
 Inside Corner**  
**1892**  
 1-1/8 x 6-1/2  
 PRIMED



**Base Block  
 Inside Corner**  
**B 895**  
 7/8 x 6-3/4  
 WHITE WOOD



**Base Block  
 Inside Corner**  
**1895**  
 1-1/8 x 6-1/2  
 PRIMED

# Base Caps | Base



**B GC1  
Chamfer Cap**  
3/4 x 1-1/16  
PRIMED 16'



**B GC2  
Slant Cap**  
3/4 x 1-1/16  
PRIMED 16'



**163  
Base Cap**  
11/16 x 1-3/8  
MDF 16'  
PRIMED 16'  
PINE 12' | 16'



**8412  
Base Cap**  
5/8 x 1-3/8  
PRIMED 16'



**8416  
Base Cap**  
5/8 x 1-5/8  
PRIMED 16'



**L 433E E1E**  
1/2 x 3-1/4  
MDF 16'



**623**  
1/2 x 3-1/4  
MDF 8' | 16'  
9/16 x 3-1/4  
PRIMED 8' | 16'  
PINE 8' | 16'



**663**  
9/16 x 3-1/4  
PRIMED 8' | 16'  
PINE 8'



**713**  
9/16 x 3-1/4  
PRIMED 8' | 16'  
PINE 8' | 16'



**753**  
9/16 x 3-1/4  
PRIMED 16'



**L 432 E1E**  
9/16 x 3-1/2  
PRIMED 16'



**9750**  
11/16 x 3-1/2  
PRIMED 16'

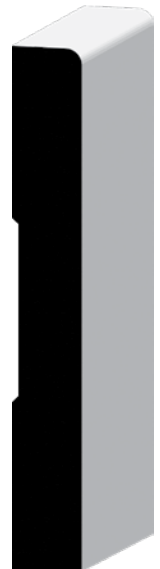

**L 414 E1E**  
9/16 x 4-1/4  
PRIMED 8' | 16'





**620**  
 1/2 x 4-1/4  
 MDF 8' | 16'  
 9/16 x 4-1/4  
 PRIMED 8' | 16'  
 PINE 8'



**750**  
 9/16 x 4-1/4  
 PRIMED 16'



**B G412**  
 11/16 x 4-1/2  
 PRIMED 16'



**618**  
 9/16 x 5-1/4  
 PRIMED 16'



**163E**  
 19/32 x 5-1/4  
 MDF 8' | 16'  
 11/16 x 5-1/4  
 PRIMED 16'

**L 163E**  
 9/16 x 5-1/4  
 PINE 16'



**738**  
 9/16 x 5-1/4  
 PRIMED 8' | 16'



**B 312**  
 19/32 x 5-1/4  
 MDF 16'



**WB514**  
 9/16 x 5-1/4  
 PRIMED 16'

# Base



**750W**  
9/16 x 5-1/4  
PRIMED 16'



**L 514 E1E**  
9/16 x 5-1/4  
PRIMED 8' | 16'



**9243**  
3/4 x 5-1/4  
MDF 16'



**256 BASE**  
11/16 x 5-1/2  
MDF 16'



**B G512**  
9/16 x 5-1/2  
MDF 16'  
PRIMED 16'



**512E E1E**  
1/2 x 5-1/2  
MDF 16'



**5 STBA**  
11/16 x 5-1/2  
PRIMED 16'



**5 SCBA**  
11/16 x 5-1/2  
PRIMED 16'

**L 512 E1E**  
9/16 x 5-1/2  
PRIMED 16'



**SCBA**  
11/16 x 7  
PRIMED 16'



**STBA**  
11/16 x 7  
PRIMED 16'



**263**  
11/16 x 7  
MDF 16'  
PRIMED 16'



**7163**  
19/32 x 7-1/4  
MDF 16'

**7163E**  
11/16 x 7-1/4  
PRIMED 16'



**L 714E E1E**  
9/16 x 7-1/4  
PRIMED 16'

**714E E1E**  
1/2 x 7-1/4  
MDF 16'

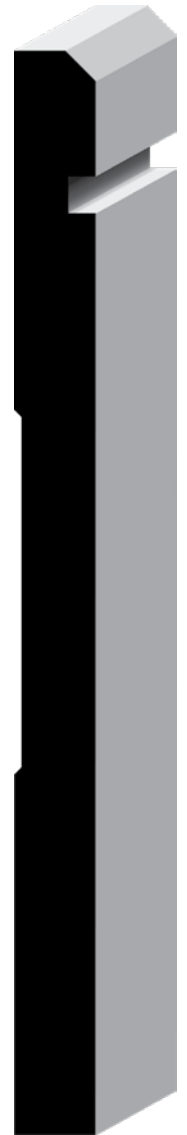

**B G712**  
9/16 x 7-1/2  
MDF 16'  
PRIMED 16'



# Crown

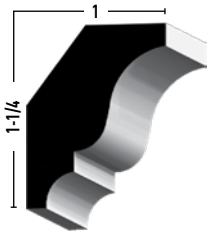

**68**  
9/16 x 1-5/8  
PRIMED 8' | 12'

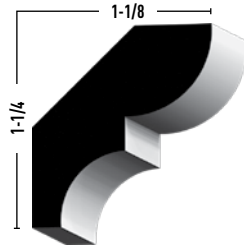

**75**  
9/16 x 1-5/8  
PRIMED 8' | 16'  
PINE 8' | 16'

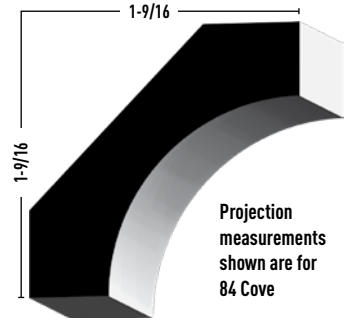

Projection  
measurements  
shown are for  
84 Cove

**84 Cove**  
9/16 x 2-1/4  
PINE RL

**86**  
9/16 x 1-5/8  
PINE 8' | 12' | 16'

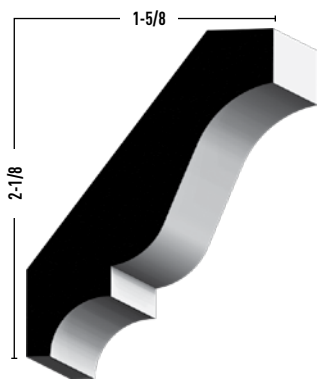

**53**  
9/16 x 2-5/8  
PRIMED 8' | 16'  
PINE 16'

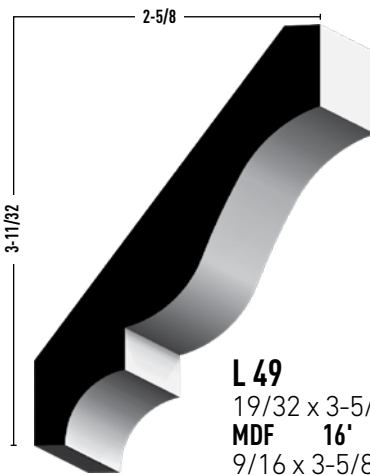

**L 49**  
19/32 x 3-5/8  
MDF 16'  
9/16 x 3-5/8  
PRIMED 16'  
PINE 8' | 12'

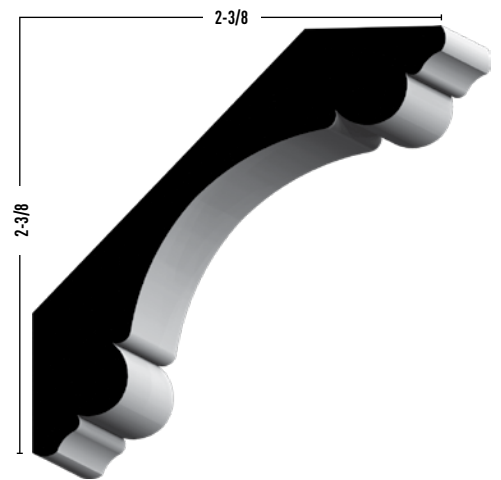

**L 340**  
11/16 x 3-3/8  
MDF 8' | 12'

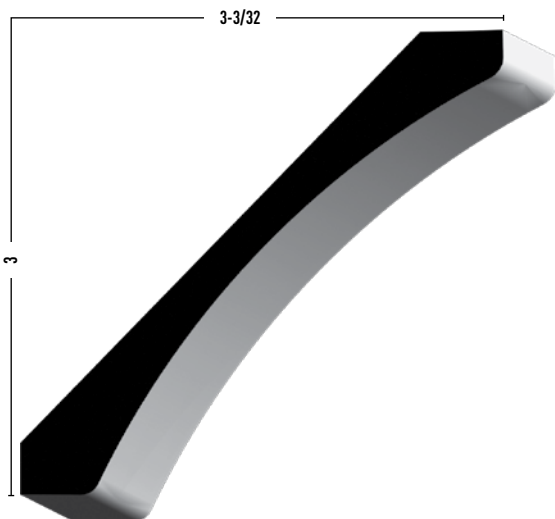

**E519**  
9/16 x 4-1/4  
MDF 16'

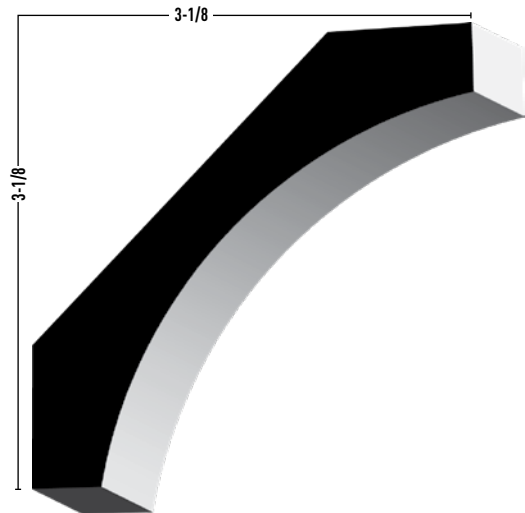

**81**  
1-1/16 x 4-5/8  
PRIMED 16'

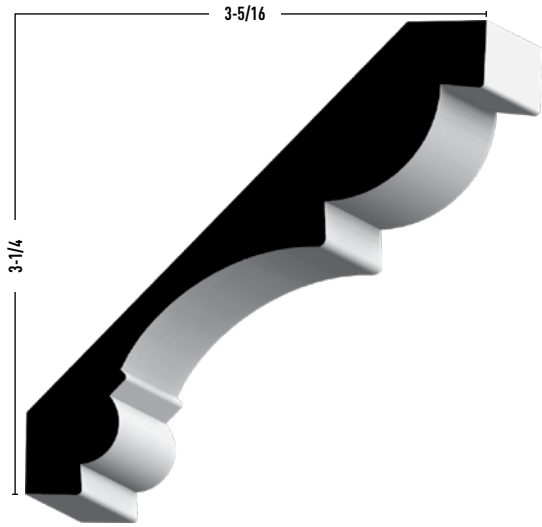

**185**  
 $11/16 \times 4-5/8$   
**MDF 16'**

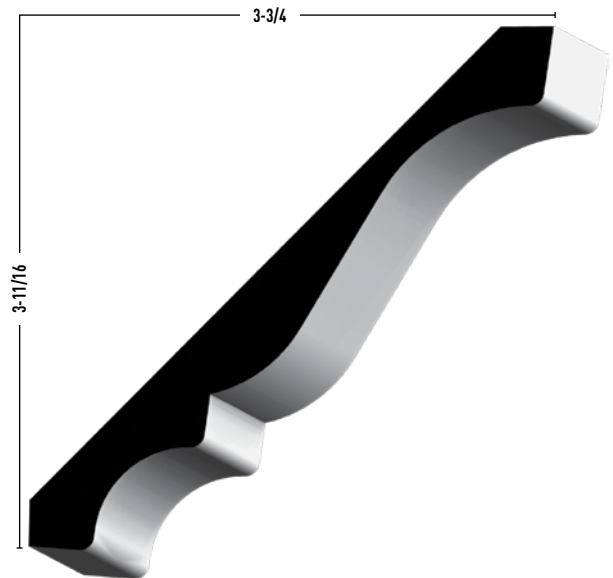

**L 45**  
 $19/32 \times 5-1/4$   
**MDF 16'**

**N 45**  
 $11/16 \times 5-1/4$   
**PRIMED 16'**

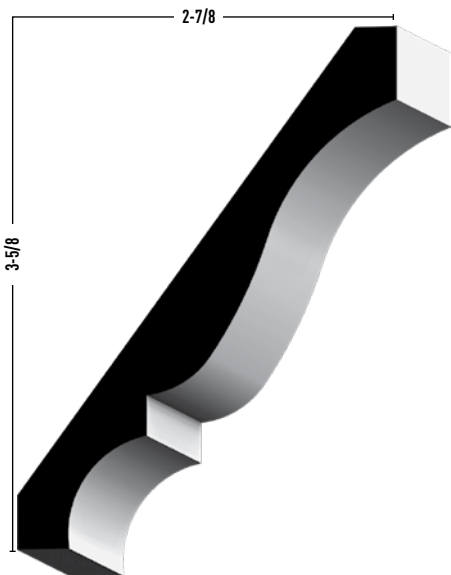

**L 47**  
 $19/32 \times 4-5/8$   
**MDF 16'**  
 $9/16 \times 4-5/8$   
**PRIMED 16'**  
**PINE 16'**

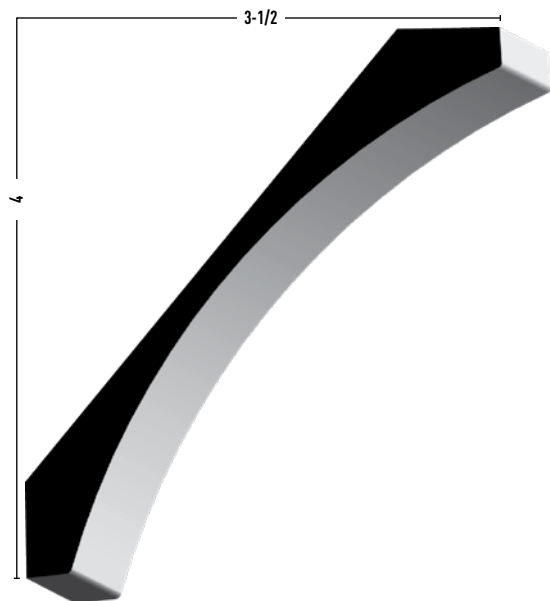

**CR291**  
 $3/4 \times 5-1/4$   
**MDF 16'**

# Crown

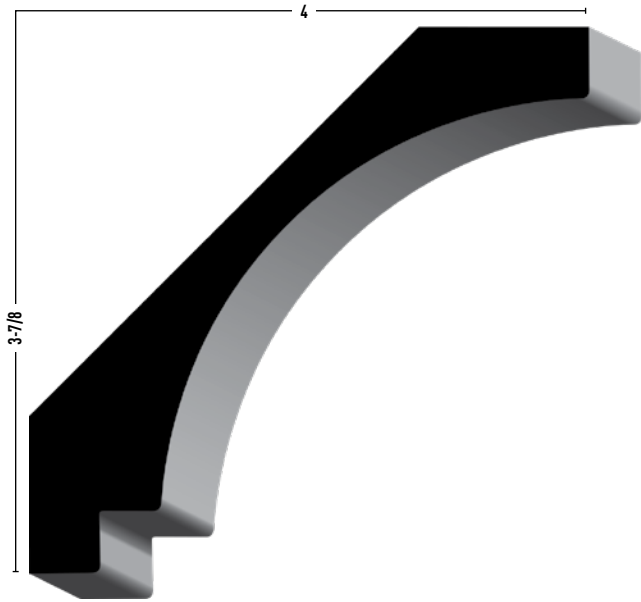

**530**  
1-3/16 x 5-1/2  
MDF 16'

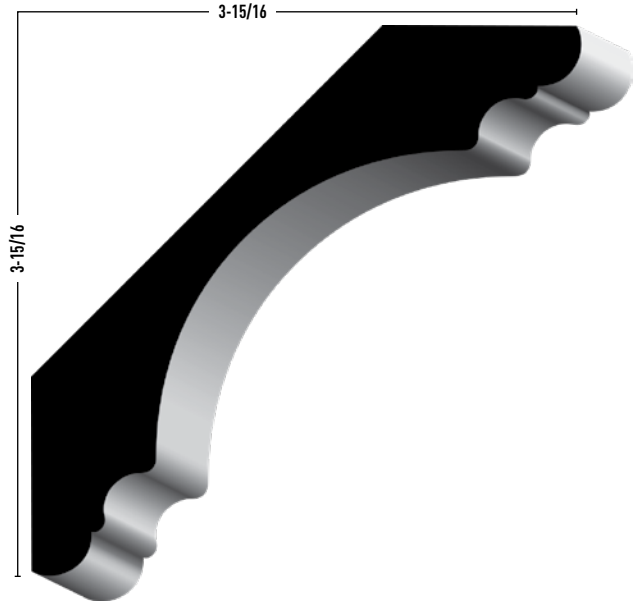

**EC512**  
1-3/16 x 5-1/2  
MDF 16'

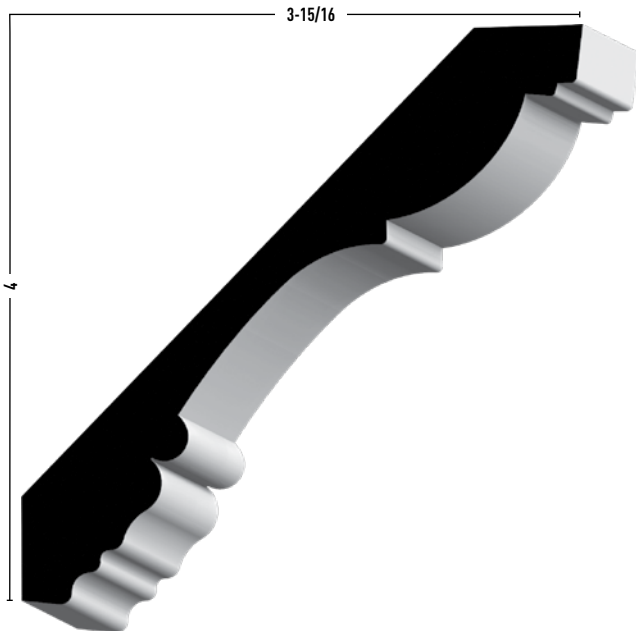

**L 201**  
13/16 x 5-5/8  
MDF 16'

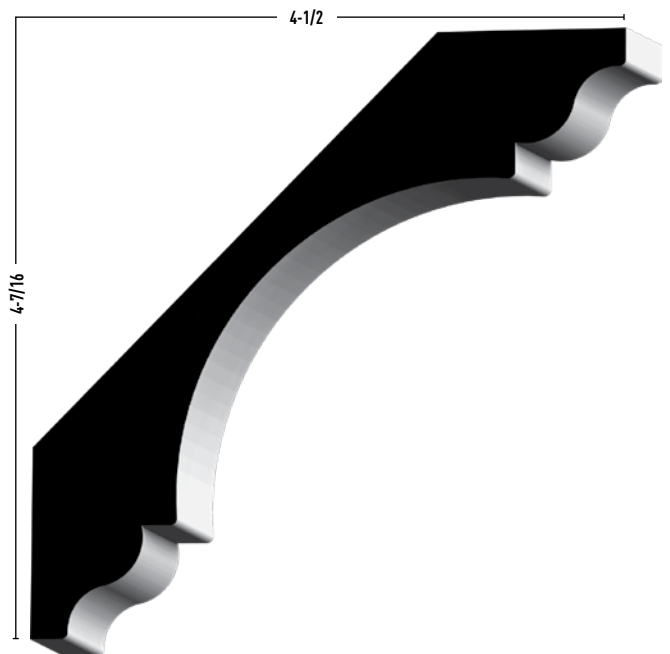

**041**  
1-3/16 x 6-5/16  
MDF 16'



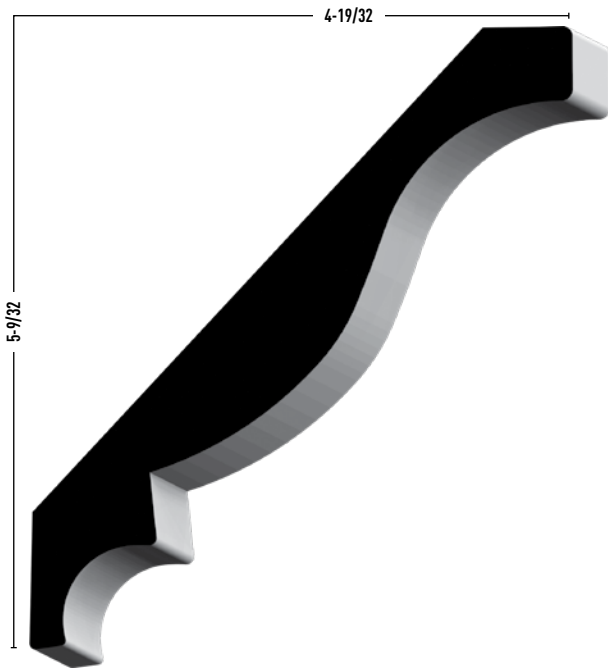

**043**  
1 x 6-15/16  
MDF 16'

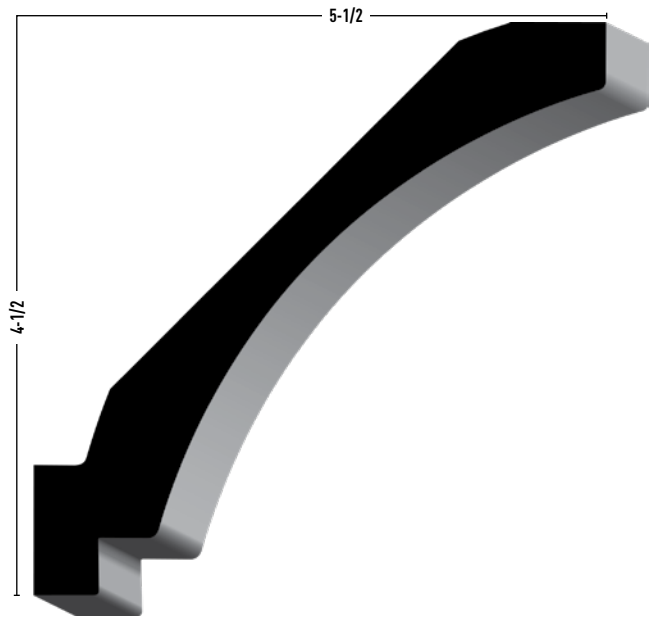

**730**  
1-3/16 x 7  
MDF 16'

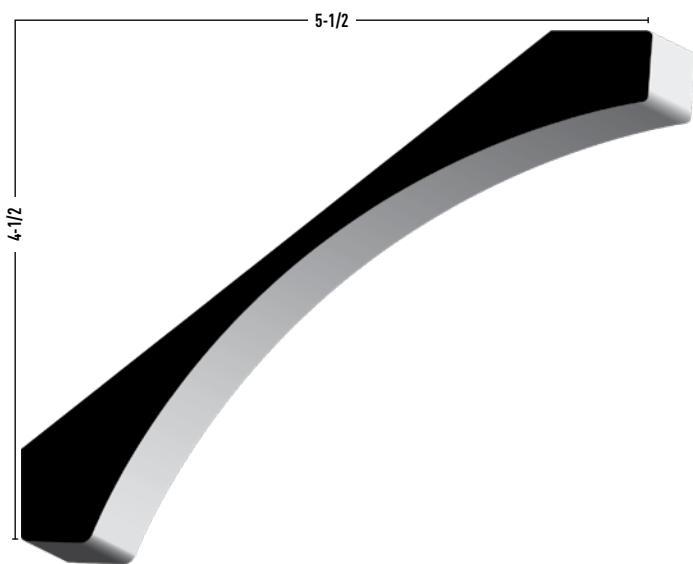

**505**  
1 x 7  
MDF 16'

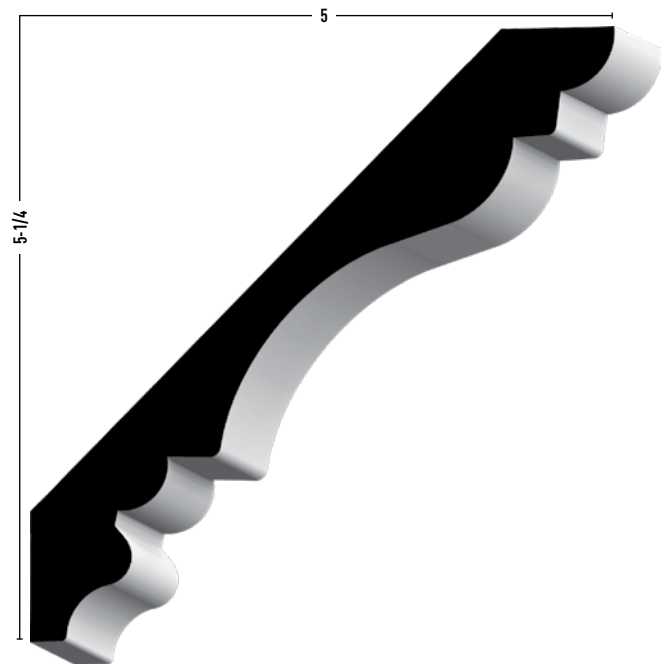

**721**  
1 x 7-1/4  
MDF 16'

# Crown Blocks

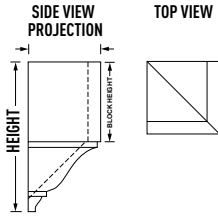

**Inside Corner**

**1888 - Medium**  
 2-5/8 x 2-5/8 x 5-5/8  
 PINE | PRIMED

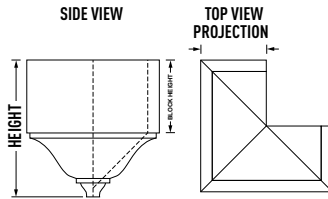

**Middle**

**1888 - Medium**  
 2-5/8 x 5-1/2 x 5-5/8  
 PRIMED

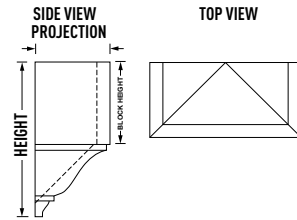

**Outside Corner**

**1888 - Medium**  
 5-5/8 x 7-3/4 x 6-1/4  
 PINE | PRIMED

**1898 - Medium**  
 3-1/8 x 2-27/32 x 5-7/8  
 WHITE WOOD

**1899 - Large**  
 4-3/16 x 3-11/16 x 7-3/4  
 WHITE WOOD



**Inside Corner**

**1889 - Large**  
 3-1/2 x 3-1/2 x 7-1/2  
 PINE



**Outside Corner**

**1889 - Large**  
 7-1/2 x 10 x 8  
 PINE

# Wall Rails

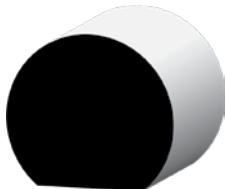

**231 Wall Rail**  
 1-1/2 x 1-11/16  
 DFIR 8' | 12'  
 SPINE 8' | 12' | 16'

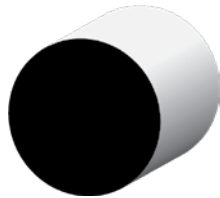

**L 232 Closet Pole**  
 1-1/2 Full Round  
 SPINE 8'

**L 233 Closet Pole**  
 1-1/4 Full Round  
 DFIR RL  
 LVL 16  
 Laminated Veneer Lumber

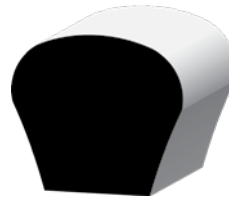

**230 Wall Rail**  
 1-1/2 x 1-11/16  
 SPINE 16'

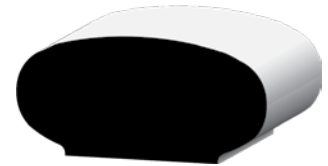

**240 Wall Rail**  
 1-1/4 x 2-1/4  
 SPINE 8' | 12' | 16'  
 PRIMED 16'

# Stools



**6 1021**  
11/16 x 6-1/2  
PRIMED 16'  
19/32 x 6-1/2  
MDF 16'

**7 1021**  
19/32 x 7-1/4  
MDF 16'  
11/16 x 7-1/4  
PRIMED 16'



**358 Threshold**  
5/8 x 3-5/8  
OAK 37" | 73"



**458 Threshold**  
5/8 x 4-5/8  
OAK 37" | 73"



**4 1021**  
11/16 x 4-1/2  
PRIMED 16'

**1021**  
11/16 x 5-1/4  
MDF 16'  
PRIMED 8' | 16'



**L 1020**  
1-1/16 x 5-1/4  
PRIMED 16'

# Window & Door Miscellaneous



**180 Brick Mould**  
1-1/4 x 2  
PRIMED 7' | 10' | 17'  
PVC 18'  
PVC (PREMITERED) 2'8" | 3'0" | 7'1"



**1305 T-Astragal**  
1-1/4 x 2  
PRIMED 7' | 8'



**L 210 Shingle Mould**  
5/8 x 1-5/8  
PRIMED 16'



**142 Screen Mould**  
1/4 x 3/4  
PINE 8'



**133 Flat Astragal**  
11/16 x 1-3/4  
PRIMED RL



**144 Beaded Screen Mould**  
1/4 x 3/4  
PINE 8'



**S 1196 Extension Jamb**  
11/16 x 2  
PRIMED 16'

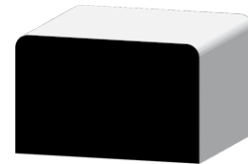

**2 Extension Mullion**  
1-1/4 x 2  
PRIMED 7'



# Stops



**888 E1E**  
3/8 x 1-1/8  
PRIMED 7'



**L 878 E2E**  
7/16 x 1-1/8  
PRIMED 8'3"



**L 888 E2E**  
3/8 x 1-1/8  
PRIMED 7'



**887 E1E**  
3/8 x 1-1/4  
MDF 7'



**876 E1E**  
7/16 x 1-3/8  
PRIMED 16'



**886 E1E**  
3/8 x 1-3/8  
PRIMED 7' | 16'  
PINE 7'



**947**  
3/8 x 1-1/4  
PRIMED 7'  
OAK 7'  
PINE 7' | 10'



**946**  
3/8 x 1-3/8  
PRIMED 7' | 16'  
PINE 7' | 10'  
MDF 7'



**936**  
7/16 x 1-3/8  
PRIMED 7' | 16'  
PINE 7'

# Mullions



**L 887 E2E**  
3/8 x 1-1/4  
OAK 7'  
PINE 7'



**L 983**  
3/8 x 1-5/8  
PINE 8'



**958**  
3/8 x 1-1/2  
PINE 8'

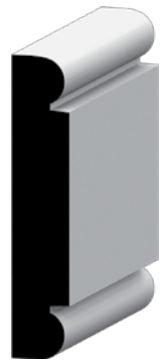

**956**  
3/8 x 2  
PINE 8'

# Panel Mould | Ply Caps



**183 Panel Mould**  
9/16 x 1-1/8  
PINE RL



**L 184 Panel Mould**  
1/2 x 1-1/2  
PRIMED 16'

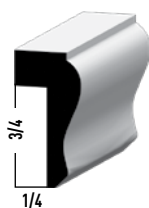

**292 Ply Cap**  
9/16 x 1-1/8  
PINE 8'

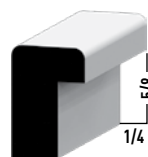

**280 Back Band**  
11/16 x 1-1/8  
PRIMED 16'

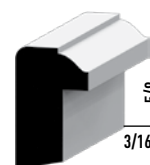

**281 Back Band**  
11/16 x 1-1/8  
PRIMED 16'  
PINE 8'

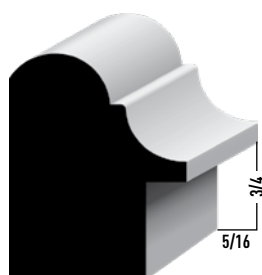

**L CAP EC**  
1-3/8 x 1-3/4  
PRIMED 16'



**1219 Ply Cap**  
11/16 x 1-5/8  
PINE 8'

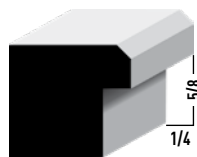

**B G200 Bevel Nose Back Band**  
1-1/16 x 1-1/16  
PRIMED 16'



**B G250 Eased Nose Back Band**  
1-1/16 x 1-1/16  
PRIMED 16'

## Chair Rails



**390 Chair Rail**  
11/16 x 2-5/8  
PRIMED 8' | 16'  
PINE 8'



**302 Chair Rail**  
1-1/16 x 2-3/4  
PRIMED 16'



**297 Chair Rail**  
19/32 x 3  
MDF 16'  
11/16 x 3  
PRIMED 16'



**300 Chair Rail**  
1-1/16 x 3  
PRIMED 16'



**L 956W Backer Bead**  
7/16 x 4-1/4  
PRIMED 16'

# Miscellaneous



**126 Shoe**  
 $1/2 \times 3/4$   
**PRIMED 8' | 12' | 16'**  
**OAK 8' | RL**  
**PINE 12' | 16'**

**127**  
 $7/16 \times 3/4$   
**PRIMED 16'**

**129**  
 $7/16 \times 11/16$   
**PINE 16'**



**L 254 Craftsman Shoe**  
 $7/16 \times 3/4$   
**PRIMED 16'**



**131 Ogee Shoe**  
 $1/2 \times 3/4$   
**PRIMED 16'**



**B G100 Shoe**  
 $5/8 \times 1$   
**PRIMED 16'**

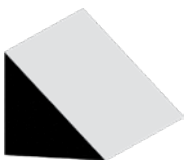

**995 Chamfer**  
 $3/4 \times 3/4$   
**PINE 8' | RL**



**103 Quarter Round**  
 $1-1/16 \times 1-1/16$   
**PINE RL**

**105**  
 $3/4 \times 3/4$   
**OAK 8'**  
**PINE 8' | RL**

**106**  
 $11/16 \times 11/16$   
**PRIMED 8' | 16'**  
**PINE 8' | 12' | 16'**

**108**  
 $1/2 \times 1/2$   
**PINE 8' | 16'**



**122 Half Round**  
 $3/8 \times 11/16$   
**PINE 8'**

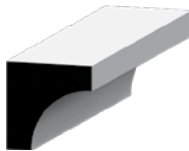

**93 Cove**  
 $3/4 \times 3/4$   
**OAK 8'**

**100**  
 $11/16 \times 11/16$   
**PRIMED 16' | RL**  
**PINE 8' | 16'**  
**POPLAR, OAK, WOAK**  
**2L**  
 (2L = 12' and Longer)



**144 Beaded Screen Mould**  
 $1/4 \times 3/4$   
**PINE 8'**

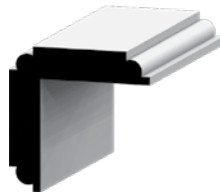

**202 Corner Guard**  
 $1-1/8 \times 1-1/8$   
**PINE 8'**



**254 Parting Bead**  
 $1/2 \times 3/4$   
**PRIMED 16'**  
**PINE 16'**

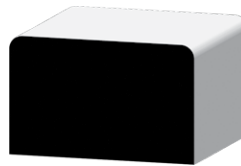

**2 Extension Mullion**  
 $1-1/4 \times 2$   
**PRIMED 7'**



**S 1196 Extension Jamb**  
 $11/16 \times 2$   
**PRIMED 16'**

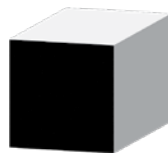

**239**  
 $3/4 \times 3/4$   
**PINE 8'**



**142 Screen Mould**  
 $1/4 \times 3/4$   
**PINE 8'**

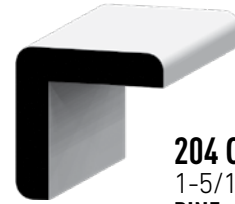

**204 Corner Guard**  
 $1-5/16 \times 1-5/16$   
**PINE 8'**

**205**  
 $1-1/16 \times 1-1/16$   
**OAK 8'**  
 $1-1/8 \times 1-1/8$   
**PRIMED 8'**  
**PINE 8'**

**206**  
 $3/4 \times 3/4$   
**PINE 8'**



**5 263 Lattice**  
 $1/4 \times 5-1/4$   
**PINE RL**

**W 266**  
 $1/4 \times 1-5/8$   
**PINE 8'**

**L 266**  
 $1/4 \times 1-1/2$   
**PRIMED 8'**  
**PINE 8' | 10'**

**L 267**  
 $1/4 \times 1-3/8$   
**PINE 8' | 16'**

**L 268**  
 $1/4 \times 1-1/8$   
**PINE 8' | RL**



**L 249 Screen Stock**  
 $1/2 \times 1-5/8$   
**PINE 8'**

**L 247**  
 $1/2 \times 2$   
**PINE 8'**





**L CAP EC**  
 1-3/8 x 1-3/4  
**PRIMED 16'**  
 Use with ECB product



**B G312** Casing w/**B G200** Back Band Casing | **B G312** Base | **B G100** Shoe | **SL16** Shiplap



**SL18**  
**Nickel Gap**  
**Shiplap**  
 11/16 x 7-1/4  
**MDF 16'**



**L SL18**  
**Nickel Gap**  
**Shiplap**  
 5/8 x 7-1/4  
**PRIMED 16'**



**1X6 EC**  
**Wainscoting**  
 23/32 x 5-1/2  
**PRIMED 16'**



**SL16**  
**Nickel Gap**  
**Shiplap**  
 11/16 x 5-1/4  
**MDF 16'**

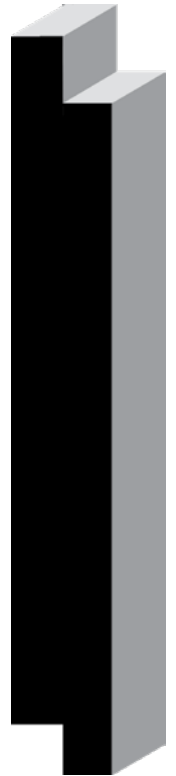

**L SL16**  
**Nickel Gap**  
**Shiplap**  
 5/8 x 5-3/8  
**PRIMED 16'**

Sizes and Profiles on PRIMED shiplap may vary slightly

**WARNING:** Drilling, sawing, sanding or machining wood products can expose you to wood dust, a substance known to the State of California to cause cancer. Avoid inhaling wood dust or use a dust mask or other safeguards for personal protection. For more information go to [www.P65Warnings.ca.gov/wood](http://www.P65Warnings.ca.gov/wood)

# Columns and Porch Post



If your project requires decorative support Columns or Porch Posts call us for information. Or check out the styles and products available at:

**TURNCRAFT.COM**





A NOVO Building Products Company

**ALLENTOWN DISTRIBUTION CENTER  
STOCKED STAIR PARTS**



# In-Stock Stair Parts



**Rails with  
Fittings,  
Goosenecks, &  
Volutes**

**Treads, False Treads  
& Tread Brackets**

**Iron Balusters**

**Iron Accessories**

**Craftsman Wood  
Balusters**





# In-Stock Stair Parts

**Square Top  
Wood Balusters**

**Pin Top Wood Balusters**

**Over the Post Newels**

**Post to Post Newels**

**Box Newels**

**Newel/Rail Installation  
Hardware**



For more information scan to visit [NOVOBP.COM](http://NOVOBP.COM)

# Moulding Index

Pattern	Pg #
2	49, 52
41	46
43	47
L 45	45
N 45	45
L 47	45
L 49	44
53	44
68	44
75	44
81	44
84	44
86	44
93	52
B G100	20, 52
100	52
103	52
105	52
106	52
108	52
122	52
126	52
129	52
131	52
133	49
142	49, 52
144	49, 52
163	40
L 163E	41
163E	41
180	49
183	51
L 184	51
185	45
B G200	21, 51
L 201	46
202	52
204	52
205	52
206	52
L 210	49
B G212	21, 34
230	48
231	48
L 232	48
L 233	48
239	52
240	48
L 247	52
L 249	52

Pattern	Pg #
B G250	21, 51
L 254	20, 52
254	52
256	42
263	43
5 263	52
W 266	52
L 266	52
L 267	52
L 268	52
280	51
281	51
292	51
297	51
300	51
302	51
B 312	41
B G312	21, 35
WC312	21, 35
312	35
327	34
W 331	35
331	34
PB 334	38
334C	38
L 340	44
L 356	34
356	34
358	49
L 361	35
361	34
366	34
366A	34
376	34
390	51
B G412	20,41
L 412	21, 36
E 412	21, 36
412	21, 36
L 414	20, 40
432	21, 36
L 432	21,36,40
L 433E	20, 40
444	35
L 445 (99)	36
445	35
445A	35
L 452	21, 34
452	21, 34
458	49

Pattern	Pg #
472	21, 34
L 473	21, 34
505	20, 47
EC512	46
B G512	20, 42
L512	20, 42
512E	20, 42
L 514	20, 42
WB514	20, 41
E 519	20, 44
530	46
535	35
618	41
620	41
623	40
B 642C	38
663	40
682	35
B G712	20, 43
713	40
L 714E	20, 43
714E	20, 43
721	47
730	47
B 734C	38
738	41
B 740C	38
PB 742	38
PB 743	38
750	41
750W	42
753	40
B 871C	38
876	50
L 878	50
886	50
L 887	50
PB 887	38
887	50
L 888	50
888	50
B 892	39
B 895	39
B 915C	38
936	50
946	50
947	50
L 956W	51
956	50
958	50

Pattern	Pg #
L 983	50
995	52
L 1020	49
1021	49
4 1021	49
6 1021	49
7 1021	49
S 1196	49, 52
B 1200C	38
1219	51
1305	49
1400C	38
P 1401	38
1402C	38
P 1403	38
1888	48
1889	48
1892	39
1895	39
1898	48
1899	48
5010	36
7163E	43
7163	43
8412	40
8416	40
8746	36
9243	42
9750	40
1X6 EC	53
B GC1	20, 40
B GC2	20, 40
L CAP	51, 53
CR291	20, 45
DC97	36
LK4	36
L BRB3	34
S RB3	36
RB3	36
5 SCBA	42
SCBA	43
SCCA	21, 35
L SL16	53
SL16	53
L SL18	53
SL18	53
5 STBA	42
STBA	43
STCA	21, 35

Misc.
See page 7 for <b>OMI Custom Manufacturing ON-Demand.</b>
See page 22-23 for <b>Build-Ups</b>
See page 24-27, 37 for <b>Decorative Accessories</b> offerings.
See page 28 for <b>Flexible Moulding.</b>
See page 29-31 for <b>Sheet Products</b> offerings.
See page 32 for <b>Board</b> offerings.
See page 33 for <b>Jamb</b> offerings.
See page 37 for <b>OMI Craftsman Architrave</b> offerings.
See page 39 for <b>Corbel</b> offerings.





## Mouldings

- Softwood Mouldings
- Hardwood Mouldings
- Blocks
- Flexible Mouldings
- Exterior Moulding



## Boards

- Softwood Boards
- Hardwood Boards
- S4S & Eased Edged
- Unfinished, Primed
- Exterior Boards



## Stair Parts

- Wood Balusters & Newels
- Iron Balusters & Newels
- Post to Post Components
- Over the Post Components
- Stock, Special Order, Custom

## Linear Collection

- Marine grade 316 stainless steel cable and hardware for interior or exterior use
- Sleek exclusive swageless cable fittings require no special tools for installation
- Newels are precut and predrilled saving hours and hours of installation time
- Hollow tube and panel infill options available
- Solid box treads for a total industrial modern design
- New code compliant handrail profile



A NOVO Building Products Company

## Decorative Millwork

- Decorative Wood Mouldings
- Mantels, Wood Beams,
- Decorative Risers
- Stained Boards

## ORNAMENTAL

— DECORATIVE MILLWORK —

A NOVO Building Products Company



## NOVO SHEET GOODS PROGRAM

- Premium Sheets For Hundreds Of Interior Applications
- Over 30 Sku Offerings
- Delivered On Your Next Truck Along With Your Moulding And Millwork





# NOVOBP.COM

Explore our comprehensive collections of mouldings, stair parts, boards, and exterior millwork as well as find inspiration for every room in the home.



## Allentown Distribution Center

Allentown Commerce Park Building 1  
2027-35 S. 12th Street | Allentown, PA 18103

**P: 800.253.9000 | F: 800.772.5574**

© 2023 NOVOBP, Allentown (Rev. 12/23)

NOVO reserves the right to make changes to the products listed in this catalog without notice and without responsibility for existing units. Drawings may not be to exact scale.

For more information  
scan to visit  
NOVOBP.COM

